

# Comfort-Sonic<sup>®</sup>

## Ultrasonic Scaler

### P9

#### Instruction for Use



**Beyes<sup>®</sup>**  
*The Next Standard*

# Table of Contents

## 1. The installation and components of equipment

1.1 Introduction .....	P3
1.2 Components .....	P3
1.3 The main technical specifications.....	P3
1.4 Installation of the main components.....	P4-6

## 2. Product function and operation

2.1 scaling function.....	P7-8
2.2 Auto-water supply function .....	P9
2.3 Endo function.....	P9-10

## 3. Sterilization and maintenance

3.1 Sterilization of detachable handpiece.....	P10
3.2 Sterilization of scaling tips and endochuck.....	P10
3.3 Sterilization of torque wrench and endo wrench.....	P10
3.4 Cleaning of tips, endochuck, torque wrench and endo wrench.....	P10-13
3.5 Troubleshooting and notes .....	P10-13

## 4. Precaution

4.1 Notice when using equipment .....	P13
4.2 Contraindication.....	P13-14
4.3 Storage and maintenance .....	P14
4.4 Transportation .....	P14
4.5 Working condition .....	P14

## 5. After service.....

P14

## 6. Symbol instruction .....

P15

## 7. Environmental Protection.....

P16

## 8. Manufacturer's rights .....

P16

## 9. For technical data, please contact .....

P16

## 10. Declaration of conformity

10.1 Product conformity the following standards.....	P16
10.2 Declaration of conformity.....	P16-19

# 1. The installation and components of equipment

## 1.1 Introduction

Beyes Dental Canada Inc. Is a professional manufacturer in researching , developing and producing ultrasonic piezo scalers. This product is mainly used for teeth cleaning and is also an indispensable equipment for tooth disease preventions and treatments. The new product COMFORT-SONIC ultrasonic piezo scaler has scaling, perio, endo and auto-water supply functions. It contains the following features:

1.1.1. Aith auto-water supply function, easier operation

1.1.2. The inner water pipe is made from antiseptic materials, clinical fluids, such as Hydrogen peroxide, chlorhexidine and sodium hypochlorite, etc, can be suited perfectly under the mode of auto-water supply system so that the performance of perio and endo is improved dramatically.

1.1.3. The handpiece is detachable and can be autoclaved to the temperature of the 135°C and the pressure of 0.22Mpa.

1.1.4. Automatic frequency tracking ensures that the machine always works on the best frequency and it also performs steadily.

1.1.5. Controlled by PC, easy operation and more efficient for scaling.

These features make COMFORT-SONIC become a new generation product in the world dental market.

## 1.2 Components

1.2.1. (The components of the machine are listed in the packing list)

The scaling tips and their accessories are not listed in this instruction manual completely. The detail can be found in the instruction for tips and packing list attached to the machine.

1.2.2. Product performance and structure

Ultrasonic piezo scaler is composed of electro circuit, water way and ultrasonic transducer.

1.2.3. Scope of application

Ultrasonic piezo scaler COMFORT-SONIC is used for the dental calculus elimination and root canal treatment.

## 1.3 The main technical specifications

- Adapter Input: 100V to 240V~ 50Hz/60Hz 1.2A (Max)
- Main unit input: 30VDC 1.3A
- Output primary tip Vibration excursion:  $\leq 100\mu\text{m}$
- Output half-excursion force:  $< 2\text{N}$
- Output tip vibration frequency:  $28\text{kHz} \pm 3\text{kHz}$
- Output power: 3W to 20W
- Main unit fuse: 250VT 1.6AL
- Adapter fuse: 250VT 2.0AL
- Water pressure: 0.1bar to 5bar(0.01Mpa to 0.5 Mpa)

- Weight of main unit: 1.35kg
- Weight of adapter: 0.3kg
- Operating mode : Continuous operation
- Type of protection against electric shock: Class: equipment
- Degree of protection against electric shock: Type BF applied part
- Degree of protection against harmful ingress of water : Ordinary equipment(IPX0) Protection degree against water(used on the foot switch):IPX1
- Degree of safety of application in the presence of a Flammable Anesthetic Mixture with air or with Oxygen or Nitrous Oxide: Equipment is not suitable for being used in the presence of a flammable anesthetic mixture with air or with oxygen or nitrous oxide.

## 1.4 Installation of the main components

### 1.4.1.Installation and conection.

a) The front of the main unit

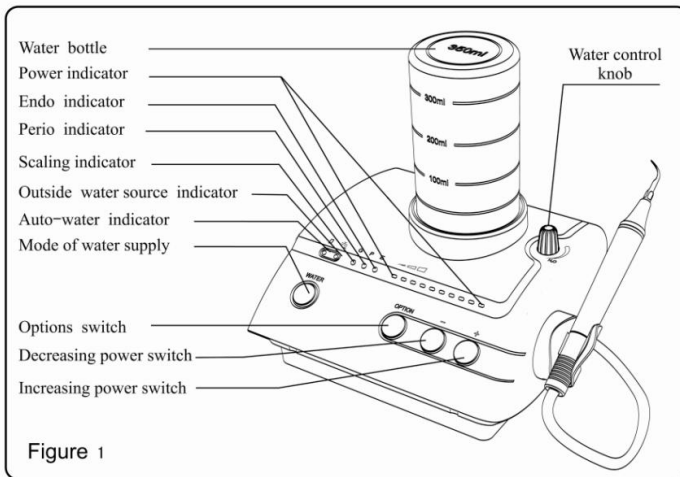

b) The back of the main unit

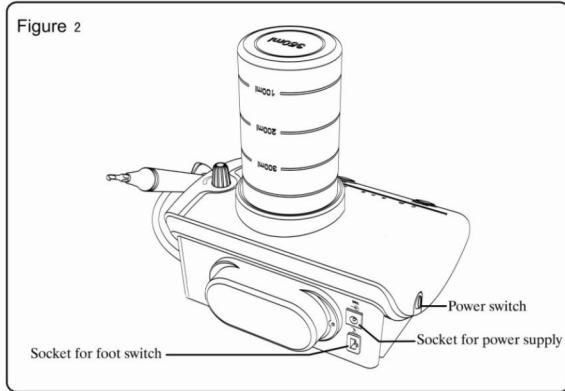

c) Connection of foot switch, adapter and main unit

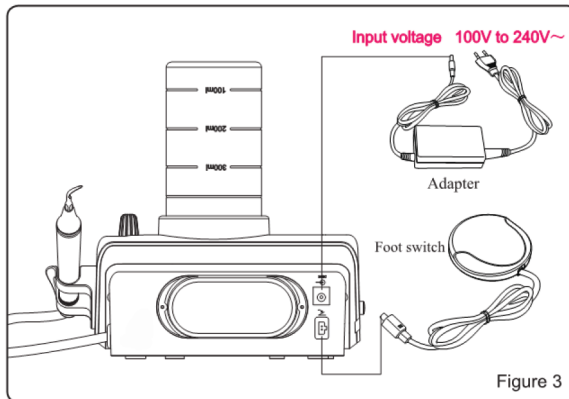

d) Water bottle installation

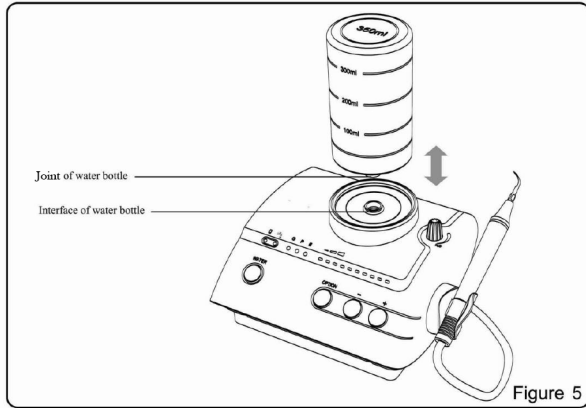

e) Connection of detachable handpiece

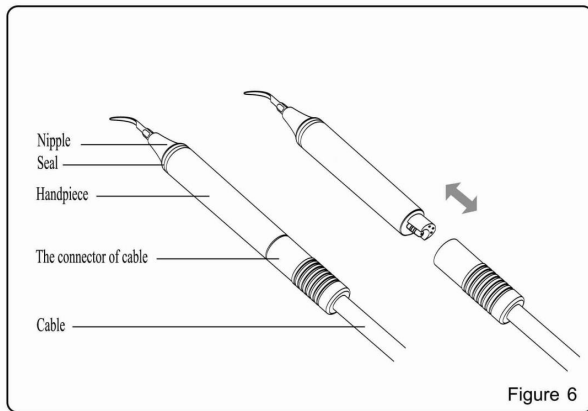

f) Installation of tip and endochuck with wrench

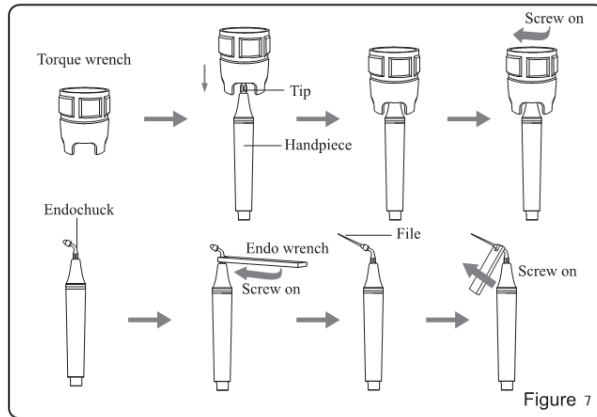

Figure 7

## 2. Product function and operation

### 2.1 Scaling funtion

#### 2.1.1 Operation

- Open the packaging box, make sure that all the parts and accessories are completed according to the packing list. Take the main unit out of the box and put it on a stable place.
- Turn the water control knob to the maximum based on symbols as shown in 3.5.2[note 1]
- Insert the plug of the foot switch to its socket (See Figure 3).
- Water line installation:
  - \* Auto-water supply  
Install the bottle reverely to the connector with adequate purified water (see figure 5)
  - \*Outside water  
Connect one end of the water pipe to the water entrance , and the other end to the purified water source (see figure 4)
- Screw the scaling tip tightly to the handpiece by torque wrench, then connect the handpiece and the connector of cable correctly.
- Insert the plug of the power source to its socket, then get through to the power (see figure 3)
- Switch on the main unit , then the scaling indicator, the first five power indicators & auto-water indicator will be lighted on.
- According to needs, push the water button to choose auto-water or outside-water. Then the indicator of chosen mode will be lighted on.
- Select a suitable scaling tip as you need, screw it on the handpiece tightly by the torque wrench(see figure 7)

- The normal frequency is extremely high. Under the normal working state of scaling tips, a light touch and a certain to-and-fro motion will eliminate the tartar without heating. Overexertion and long-time lingering are forbidden.
- Vibrating intensity: Adjust the vibration intensity as you need, generally turn the knob to the middle grade. According to patient's different sensitivity and the rigidity of the gingival tartar, adjust the vibration intensity during the clinical treatment.
- Water volume adjust: Step on the foot switch, and the tip will begin to vibrate, then turn the water control switch to form fine spray to cool down the handpiece and clean the teeth.
- The handpiece can be handled in the same gesture as a pen in hand.
- After finishing operation, keep the machine working for 30 seconds on the water supply condition in order to clean the handpiece and the scaling tip.
- Unscrew the scaling tip and pull out handpiece, then sterilize them.

**Notice**

Don't pull the handpiece out when the foot switch is stepped on and the ultrasonic vibration is produced from the machine.

2.1.2 Instruction for main components of detachable handpiece(see figure 6):

- Nipple: The nipple can be removed. You can screw out the nipple and clean the pole with alcohol termly.
- Handpiece seal: The seal can't be removed.
- Handpiece: The main part of the whole handpiece, can be autoclaved under the high temperature and pressure.
- The connector of the cable: Connect the handpiece with the water source and power supply of the main unit.

**Notice**

Keep dry when the detachable handpiece connects to the connector of the cable.

2.1.3 Instruction of torque wrench(see figure 7)

- The torque wrench's structure is designed in special way which can control the strength of the scaling tip's installation properly and correctly. It also can guarantee the operator screw or unscrew the scaling tip effectively and keep their hands away from being scratched.
- Operation
  - a. Take the scaling tip into the torque wrench as showed in figure 7.
  - b. Tip installation: Hold the handpiece, turn the tip toward direction as showed in figure 7 with the torque wrench. Turn twice more circles when the tip stops, then the tip will be installed.
  - c. Tip's uninstillation: Hold the handpiece, turn the wrench in anti-clockwise direction direction.
  - d. Serilize it in sterilizer after each treatment.
  - e. The torque wrench must be cooled down naturally after sterilization to avoid scald when using for the next time.
  - f. Keep the torque wrench in a cool, dry and ventilated place and keep it clean.



## 2.2 Auto-water supply function

### 2.2.1. Usage process

- Pull out the water bottle vertically.
- Open the lid, fill the bottle with adequate purified water and then tighten the lid.
- Clean the joint and interface of water bottle.
- Put and place the bottle with water upside down, insert the joint into the interface vertically. (see figure 5).
- Press “WATER” to choose auto-water supply.

### 2.2.2. Notice

- Make sure the air hole and water entrance are not blocked. (see figure 8)
- Check if the cushion inside the lid is in a good condition. If it becomes deformed or it falls off, reinstall it or change to a new one.
- Tighten the lid.
- Clean the joint and interface of water bottle before each clinical operation.
- After every clinical operation with clinical liquid, change a bottle with purified water, turn the water supply to maximum, allow the machine to work with auto-water supply for 30 seconds in order to keep the water line and spare parts clean and durable.
- When the water is lower than water level lower limit, add more water to keep water pipe smooth. (see figure 9)

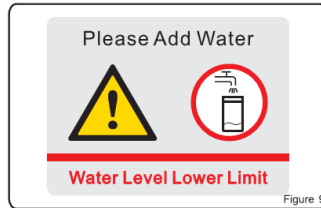
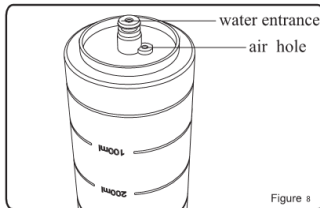

## 2.3 Endo function

### 2.3.1. Usage process

- Fix endochuck to handpiece by endo wrench (see figure 7)
- Unscrew the screw cap on the endochuck.
- Put the ultrasonic file into the hole in the front of endochuck.
- Screw down the screw cap with endo wrench to tight up the ultrasonic file.
- When ultrasonic scaler turns into endo function, only the first lead light will be on and the power will be at the 1st grade. Put the ultrasonic file into the patient's root canal slowly, step on the foot switch, during the treatment, turn up the power gradually according to the needs.

### 2.3.2 Notice

- When fixing endochuck, it must be screwed down.
- The screw cap on the endochuck must be screwed down.

- Don't press it too much when the ultrasonic file is in root canal.
- Don't step on the foot switch until the ultrasonic file is in root canal.
- The power ranged from the 1st to the 5th grades.

### 3. Sterilization and maintenance

#### 3.1 Sterilization of detachable handpiece

##### 3.1.1 Autoclaved in high temperature/pressure:

- 121OC/1bar (0.1 Mpa)
- 135OC/2.2 bar (0.22Mpa)
- Pull out the handpiece and unscrew scaling tip and endochuck after each operation.
- Pack the handpiece with sterile gauze or sterile bag before sterilizing.
- Reuse handpiece after it cools naturally in case of scalding hand.

##### 3.1.2 Notice

- Dry the cleaning liquid in the handpiece with compressed air before sterilization.
- Ensure that the scaling tip has been unscrewed from the handpiece and it could not be sterilized with others.
- Please notice whether the outer part of the handpiece is damaged during the treatment or sterilization, don't smear any protective oil on the surface of handpiece.
- There are two waterproof "o" rings at the end of handpiece. Please lubricate them with dental lube frequently, as sterilization and repeated pulling and inserting will reduce their life. Change a new one once it is damaged or worn excessively.
- The following sterilizing methods are forbidden:  
 Putting handpiece into any liquid for boiling.  
 Dipping handpiece in disinfectors such as iodine, alcohol and glutaraldehyde.  
 Sterilizing handpiece into oven or microwave oven for baking.

##### 3.2 Sterilization of scaling tips and endochuck.

All the scaling tips and endochuck can be autoclaved under high temperature and pressure.

##### 3.3 Sterilization of torque wrench and endo wrench

- The torque wrench and endo wrench can be sterilized in high temperature and pressure.
- The following sterilization ways for torque wrench are forbidden:  
 Baise in liquor.  
 Dipping in iodine, alcohol or glutaraldehyde.  
 Sterilizing in oven or microwave oven.

#### Notice

We are not responsible for any damage of the torque wrench directly or indirectly made by any ways which indicated in 3.1e and 3.3b.

##### 3.4 Cleaning of tips, endochuck, torque wrench and endo wrench

The scaling tip, endochuck, torque wrench and endo wrench can be cleaned by ultrasonic cleaner.

### 3.5 Troubleshooting and notes

#### 3.5.1 Troubleshooting

Fault	Possible cause	Solutions
The scanning tip doesn't vibrate and there is no water flowing out when stepping on the foot switch	The power pipe plug is in loosen contact	Make the pulg insert to the socket well
	The foot switch is in loosen contact	Insert the foot switch to its socket tightly
	The fuse in the main unit is broken	Contact our dealers or us
The scaling tip doesn't vibrate	The tip is in loosen contact	Screw the tip on the handpiece tightly
There is water flowing out when stepping on the foot switch		(see figure7)
	Something wrong with the handpiece	Send the handpiece to our company to repair
	Something wrong with the cable	Contact our dealer or us
The scaling tip vibrates but there is no spray when stepping on the foot switch	The water control switch is not on	Turn on the water control switch [note 1]
	There is impurity in the electric-magnetic valve	Contact our dealers or us
	The watere system is blocked	Clean the water pipe by multi-function syringe[note 2]
There is still water flowing out after the power is off	There is impurity in the electric-magnetic valve	Contact our dealers or us
The handpiece generates heat	The water control switch is in a low setting	Turn the water control switch to a higher grade[note2]
The amount of spouting water is too little	The water pressure is not high enough	Make the water pressure higher
	The water pipe is blocked	Clean the water pipe by multi-function syringe[note2]
The vibration of tip becomes weak	The tip hasn't been screwed on to the handpiece tightly	Screw the tip on the handpiece tightly(see figure7)
	The tip is loosen because of vibration	Screw on the tip tightly(see figure7)
	The coupling between the handpiece and the cable isn't dry	Dry it by the hot air
	The tip is damaged[note 3]	Change to a new tip
There is water seeping from the coupling between the handpiece and the cable	The waterproof "O" ring is damaged	Change to a new "O" ring
The ultrasonic doesn't vibrate	The screw is loosen	Tighten it
	Endochuck is damaged	Change to a new endochunck
There is noise coming from the endochuck	The screw is loosen	Tighten it
Peristaltic leak	The inner water pipe cracks	Replace a new peristaltic pump
There is no water coming out from the handpiece(automatic water supply mode)	There is air in the water pipe	Turn the water control to the Max, reinsert the bottle.

**If the problem still can't be solved, please contact with local dealer or manufacturer.**

### 3.5.2 Notes

- [Note1] Turn the water control switch toward direction showed in symbol till not be able to turn anymore, it comes to the min, on the contrary direction, the water volume increases.
- [Note2] Clean the water pipe with the Multi-function syringe of the dental unit (see figure 10)
  - a. Cut the water pipe from a distance of 10cm to 20cm from the water entrance.
  - b. Turn on the electricity and get through to the power.
  - c. Connect the multi-function syringe of dental unit to the water pipe.
  - d. Disassemble the tip or handpiece
  - e. Step on the foot switch.
  - f. Turn on the switch of the multi-function syringe, press the water into the machine and the impurity blocked in the water pipe can be eliminated.
- [Note3] If the scaling tip is screwed on tightly and there is fine spray too, the following phenomena show that the scaling tip is damaged:
  - a. The vibrating intensity and the water spray degree become weak obviously.
  - b. During treatment, it will produce the sound like “buzz” from the scaling tip.
- Note 4.
  - a. Pull out the water bottle vertically.
  - b. Remove the bolt with screwdriver.(see figure 11)
  - c. Pull the two fasten ring out to the right, then pull the peristaltic pipe out to the right. (see figure 12)
  - d. Pull the peristaltic out from the drive pole, and install the new peristaltic back to the same position.(see figure 12)
  - e. Install the fasten rings onto the ends of pipes, then insert the pipes into water-in and water-out joints. Push the fasten rings to mid of water-in and water-out joints. (see figure12)
  - f. Install the lid.
- Notice :
  - a. Dry the drive pole to avoid being slippery.
  - b. Install the peristaltic onto the drive pole carefully and lightly to avoid the damage of the inner structure of the machine.
  - c. After changing a new peristaltic, turn water supply to max and allow the machine to work with auto-water supply for 30 seconds in order to be compatible with peristaltic and its pipes.

**Fig 11**

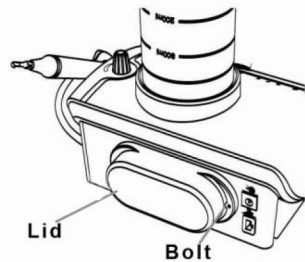

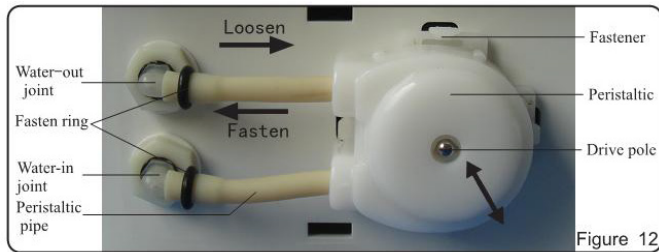

## 4. Precaution

### 4.1 Notice when using equipments

- 4.1.1 Keep the scaler clean before and after operation.
- 4.1.2 The handpiece, scaling tip, torque wrench, endo wrench and endochuck must be sterilized before each treatment.
- 4.1.3 Don't screw or unscrew the scaling tip and endochuck when stepping on the foot switch.
- 4.1.4 The scaling tip must be fastened and there must be fine spray or dripped from the tip when operating.
- 4.1.5 Change to a new one when the tip and ultrasonic file are damaged or worn excessively.
- 4.1.6 Don't twist the tip and endo chuck or rub them.
- 4.1.7 If using the water source without hydraulic pressure, the water surface should be one meter higher than the head of patient.
- 4.1.8 Ensure the connector of handpiece and the socket of the cable are dry before installing the handpiece.
- 4.1.9 Don't pull the cable forcibly in case of the handpiece falling off the cable.
- 4.1.10 Don't knock or rub the handpiece.
- 4.1.11 After operating, turn of the power, then pull out the plug.
- 4.1.12 We are only responsible for the safety on the following conditions:
  - The maintenance, repairment and modification are made by the manufacturer or the the authorized dealer.
  - The changed components are originated of "BEYES" and are operated according to instruction manual.
- 4.1.13 The internal screw thread of the scaling tips produced by some maunactures is coarse, rusty and collapsed. This will damage the external screw thread of the handpiece irretrievably. Please use "BEYES" brand scaling tips.
- 4.1.14 This model only matches the adapter of our company.
- 4.1.15 Keep peristaltic dry. Otherwise, its wheels will be likely to be slippery and the water supply will not work.
- 4.1.16 Clinical fluids are forbidden when the machine connects outside water source to avoid rustiness of the metal part inside machine.

### 4.2 Contraindication

- 4.2.1 The hemophilia disease patient is not allowed to use this equipment.

4.2.2 The patients or doctors with heart pacemaker are forbidden to use this equipment.

4.2.3 The patient with heart disease, pregnant women and children should be cautious with using the equipment.

### **4.3 Storage and maintenance**

4.3.1 The equipment should be handled carefully and lightly. Be sure that it is far from the vibration , and install or keep in a cool, dry and ventilated place.

4.3.2 Don't store the machine together with the articles that are combustible, poisonous, caustic, and explosive.

4.3.3 This equipment should be stored in a room where the relative humidity is  $\leq 80\%$ , atmospheric pressure is 50kPa to 106kPa, and the temperature is -10OC to 50OC.

4.3.4 If it has not been used a long time, please ensure the machine gets through to the power and water once per month for five minutes.

### **4.4 Transportation**

4.4.1 Excessive impact and shake should be prevented in transportation. Lay it carefully and lightly and don't invert it.

4.4.2 Don't put it together with dangerous goods during transportation.

4.4.3 Avoid solarization and getting wet in rain and snow during transportation.

#### **4.5 Working condition**

a) Environment temperature: 50°C to 40°C

b) Relative humidity:  $\leq 80\%$























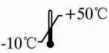

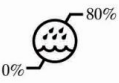
c) Atmosphere pressure: 70kPa to 106kPa

## **5. After service**

We offer one year's free repair to the equipment according to the warranty card. The repair of the equipment should be carried out by our professional technicians. We are not responsible for any irretrievable damage caused by the non-professional person.

## 6. Symbol instruction

**Beyes**<sup>®</sup>  
The Next Standard

	Beyes Trademark		Caution, consult accompanying documents
	Class II equipment		Use indoor only
	Type BF applied part		Can be autoclaved
	Alternating current		30 VDC power supply socket
	Socket for the foot switch		Water entrance pressure 0.01MPa-0.5MPa
	Adjustment for the water flow		FDA marked product
	Temperature limitation		CE marked product
	Humidity limitation		Atmospheric pressure for storage
	Date of manufacture		Atmospheric pressure for working
	Authorized Representative in the EUROPEAN COMMUNITY		Appliance compliance WEEE directive
	Add water		Manufacturer
	Mode of auto-water system		Mode of outside water source

EN ISO 9001:2008 Certificated by ISO international quality control system

EN ISO 13485:2003+AC:2007 Certificated ISO by medical instrument manufacturer quality control system.

## 7. Environmental Protection

There is no harmful factor in our product. You can deal with it based on the local law.

## 8. Manufacturer's rights

We reserve the rights to change the design of the equipment, the technique, fittings, the instruction manual and the content of the original packing list at any time without notice. If there are some differences between blueprint and real equipment, take the real equipment as the norm.

## 9. Please contact us for more information

## 10. Declaration of conformity

10.1 Product conformity the following standards.

EN ISO 14971:2000+A1:2003

EN 980:2003/ ISO 9687:1993 / EN 1041:1998

EN 60601-1:1990+A1:1993+A2:1995+A13:1996

EN 60601-1-4:2001 \* EN 60601-1-2: 2001 +A1:2006

EN ISO 7405:1997

EN ISO 10993-1:2003 / EN ISO 10993-5:1999

EN ISO 10993-10:2003+A1:2003

EN 61205:1994 / EN ISO 22374:2005

EN ISO 17664:2004 / EN ISO 17665-1:2006

10.2 EMC-Declaration of conformity

Guidance & Declaration – electromagnetic immunity		
The model COMFORT-SONIC is intended for using in the electromagnetic environment specified below. The customer or the user of the model COMFORT-SONIC should assure that it is used in such an environment.		
Emissions test	Compliance	Electromagnetic environment- guidance
RF emissions CISPR 11	Group 1	The model COMFORT-SONIC uses RF energy only for its internal function. Therefore, its RF emissions are very low and are not likely to cause any interference in nearby electronic equipment
RF emission CISPR 11	Class B	The model COMFORT-SONIC is suitable for used in domestic establishment and in establishment directly connected to a a low voltage power supply network which supplies buildings used for domestic purposes.
Harmonic emissions IEC61000-3-2	Class A	
Voltage fluctuations/ flicker emissions 1EC61000-3-3	Not applicable	



Guidance & Declaration – electromagnetic immunity			
The model COMFORT-SONIC is intended for using in the electromagnetic environment specified below. The customer or the user of the model COMFORT-SONIC should assure that it is used in such an environment.			
Immunity test	IEC 60601 test level	Compliance level	Electromagnetic environment guidance
Electrostatic discharge (ESD) IEC 61000-4-2	±6kV contact ±8kV air	±6kV contact ±8kV air	Floors should be wood, concrete or ceramic tile. If floors are covered with synthetic material, the relative humidity should be at least 30%
Electrical fast transient/burst IEC 61000-4-4	±2kV for power supply lines ±1kV for Input/output lines	±2kV for power supply lines	Mains power quality should be that of a typical commercial or hospital environment.
Surge IEC61000-4-5	±1kV differential mode , ±2kV common mode	±2kV common mode	Mains power quality should be that of a typical commercial or hospital environment.
Voltage dips, short interruptions and voltage variations on power supply input lines IEC61000-4-11	<5% UT(>95% dip in UT.) For 0.5 cycle 40% UT (60% dip in UT) For 5 cycles 70% UT (30% dip in UT) For 25 cycles <5% UT (>95% dip in UT) For 5sec	<5% UT(>95% dip in UT.) For 0.5 cycle 40% UT (60% dip in UT) For 5 cycles 70% UT (30% dip in UT) For 25 cycles <5% UT (>95% dip in UT) For 5sec	Mains power quality should be that of a typical commercial or hospital environment. If the user of the model COMFORT-SONIC requires continued operation during power mains interruptions, it is recommended that the model COMFORT-SONIC should be powered from an uninterruptible power supply or a battery.
Power frequency (50/60 Hz) magnetic field IEC61000-4-8	3A/m	Not applicable	Not applicable
NOTE UT is the a.c mains voltage prior to application of the test level.			

Guidance & Declaration – electromagnetic immunity			
The model COMFORT-SONIC is intended for using in the electromagnetic environment specified below. The customer or the user of the model COMFORT-SONIC should assure that it is used in such an environment.			
Immunity test	IEC 60601 test level	Compliance level	Electromagnetic environment guidance
Conducted RF IEC61000-4-6 Radiated RF IEC61000-4-3	150kHz to 80MHz 3Vrms 80 MHz to 2.5 GHz	3v 3V/m	Portable and mobile RF communications equipment should be used no closer to any part of the model COMFORT-SONIC , including cables, than the recommended separation distance calculated from the equation applicable to the frequency of the transmitter. Recommended separation distance 3V 3V/m $d = 1.2 \times P^{1/2} / 280\text{MHz to } 800\text{MHz}$ $d = 2.3 \times P^{1/2} / 2800\text{MHz to } 2.5\text{GHz}$ where P is the maximum output power rating of the

transmitter in watts(W) according to the transmitter manufacture and is the recommended separation distance in meters(m).  
 field strengths from fixed RF transmitters, as determined by and electromagnetic site survey, should be less than the compliance level in each frequency range.  
 Interference may occur In the vicinity of equipment marked with the following symbol:



NOTE 1 At 80 MHz end 800 MHz. The higher frequency range applies.  
 NOTE 2 There guidelines may not apply in all situations. Electromagnetic propagation is affected by absorption and reflection from structures, objects and people.

Field strengths from fixed transmitters, such as base stations for radio(cellular/cordless) telephones and land mobile radios, amateur radio, AM and FM radio broadcast and TV broadcast cannot be transmitters, and electromagnetic site survey should be considered. If the measured field strength in the location in which the model COMFORT-SONIC is used exceeds the applicable Rf compliance level above, the model COMFORT-SONIC should be observed to verify normal operation. If abnormal performance is observed, additional measures may be necessary, such as reorienting or relocating the model COMFORT-SONIC.  
 Over the frequency range 150kHz to 80MHz, field strengths should be less than 3V/m.

Recommended separation distances between portable and mobile RF communications equipment and the model COMFORT-SONIC

The model COMFORT-SONIC is intended for using in an electromagnetic environment in which radiated RF disturbances are controlled. The customer or the user of the model COMFORT-SONIC can be help prevent electromagnetic interference by maintaining a minimum distance between portable and mobile RF communications equipment (transmitters) and the model COMFORT-SONIC as recommended below, according to the maximum output power of the communications equipment.

Rated maximum output power of transmitter W	Separation distance according to frequency of transmitter m		
	150kHz to 80MHz d= 1.2×P <sup>1/2</sup>	80MHz to 800MHz d= 1.2×P <sup>1/2</sup>	800MHz to 2.5GHz d= 2.3×P <sup>1/2</sup>
0.01	0.12	0.12	0.23
0.1	0.38	0.38	0.73
1	1.2	1.2	2.3
10	3.8	3.8	7.3
100	12	12	23

For transmitters rated at a maximum output power not listed above, the recommended separation distance d in meters(m) can be estimated using the equation applicable to the frequency of the transmitter, where P is the maximum output power rating of the transmitter in watts (W) accordable to the transmitter manufacture.  
 NOTE 1 At 80MHz and 800MHz. The separation distance for the higher frequency range applies.  
 NOTE 2 There guidelines may not apply in all situations. Electromagnetic propagation is affected by absorption and reflection from structures, objects and people.

The device has been tested and homologated in accordance with EN 60601-1-2 for EMC. This does not guarantee in any way that this device will not be effected by electromagnetic interference. Avoid using the device in high electromagnetic environment. All rights of modifying the product are reserved to the manufacturer without further notice. The picture are only for references. The final interpretation rights belong to BEYES DENTAL CANADA INC.

## **WARRANTY**

Beyes Dental Canada Inc. hereby warrants that for a period of one (1) year from the date of purchases, this instrument shall be free from defects in material and workmanship and will perform satisfactorily under normal use and service.

Users **MUST** complete the online Warranty Registration Form within 30 days of the purchase date at [www.beyes.ca](http://www.beyes.ca) in order to qualify the warranty. If multiple units are purchased, fill out one registration form per unit. Please keep your dealer invoice. A copy of the invoice will be required should warranty service be required.

In the event of a breach of this warranty, Beyes liability is limited to, at Beyes option, to replace the defective product or part thereof, or reimbursement of the actual cost of the defective product. In order to take advantage of this limited warranty, the defective product must be returned to Beyes Dental Canada Inc. In no events shall Beyes be liable for any indirect, incidental, or consequential damages.

Beyes Canada warrants this product will be free from defects in material and manufacture. Beyes Dental Canada Inc. **MAKES NO OTHER WARRANTIES ACTUAL OR IMPLIED.** User is responsible for determining the suitability of the product for user's application. If this product is defective within the warranty period, your exclusive remedy and Beyes Dental Canada Inc.'s sole obligation shall be to the repair or the replacement of the Beyes products.

# Beyes<sup>®</sup>

*The Next Standard*



---

Federal law restricts this device to sale by or on the order of a dentist, physician, or any other practitioner licensed by the law of the states in which he or she practices to use or order the use of this device.

---

**Beyes Dental Canada Inc.**  
23-595 Middlefield Road  
Toronto, Ontario, M1V 3S2  
Canada  
**Tel:** 1-855-603-1888  
**Fax:** 1-855-720-1228  
**Email:** info@beyes.ca  
**Web:** www.beyes.ca



**Lotus NL B.V.**  
Koningin Julianaplein 10, le Verd,  
2595AA, The Hague,  
Netherlands  
**Tel:** +31645171879 (English)  
+31626669008 (Dutch)

**CE**  
0197



Printed in Canada  
1120EN.REV4G1924