

DENTAL IMAGING CATALOG

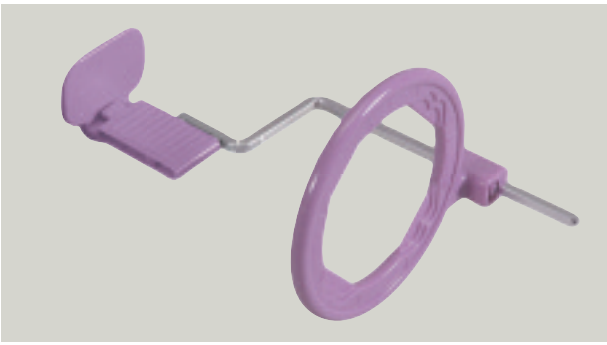

[X-ray Protective Aprons](#) [Dental X-ray Illuminators](#) [Darkroom Accessories](#) [Intraoral Dental X-ray Film](#)
[Dental X-ray Film Positioners](#) [Extraoral Dental X-ray Film](#) [Intraoral Dental X-ray Machines](#) [Dental X-ray Mounts](#) [X-ray Protective Aprons](#) [Dental X-ray Illuminators](#) [Dental X-ray Film Positioners](#)
[Intraoral Dental X-ray Machines](#) [Chemistry](#) [Specialty Film Positioners](#) [Intraoral Dental X-ray Film](#)
[Darkroom Accessories](#) [Dental X-ray Mounts](#) [X-ray Protective Aprons](#) [Dental X-ray Film Positioners](#)
[Developing Chemistry](#) [Specialty Film Positioners](#) [Extraoral Dental X-ray Film](#) [Dental X-ray Machines](#)
[Developing Chemistry](#) [Specialty Film Positioners](#) [Dental X-ray Illuminators](#) [Darkroom Accessories](#)
[Intraoral Dental X-ray Film](#) [Dental X-ray Mounts](#) [Dental X-ray Illuminators](#) [Darkroom Accessories](#)

Alphabetical Index

A

Apron, Bib	19 and 20
Auto ID Printer	22
Automatic Processor, solutions	23
Automatic Processor, cleaner	23

B

Bib Apron	19 and 20
Bite Chex DX-42 100 pieces, Size 3 Film	6
Bite-Wing Loops	11
Bite-Wing Tabs, Self Adhesive	11

C

Camera Caps	16
Cards, Printer Identification	22
Cassettes	23
Chemistry - Developer, Fixer	23
Childs Protective Apron	19 and 20
Cleaner, Processor	23
Clearing Sheets - Processor Cleaner	23
"Cushies" Film Cushions	11

D

Darkroom - Chairside	21
Darkroom Safelights	24
Darkroom Thermometers	22
Darkroom Timers	22
Dental Film	1 thru 7
Dental Film Mounts	17 and 18
Dental Hangers	22
Dental Hanger Identification Tabs	22
Dental Illuminators	21
Developer- Liquid	23
Digital Timer	22
Duplicators	23
Duplicating Film	7
D Speed Size 4 Occlusal Film	3
DV-58 Econo Pak 600 Size 2 Films	2
DV-58 Value Pak 150 Size 2 Films	2
DV-58 Fresh Pak 100 Size 2 Films	2
DV-57 Value Pak 150 Size 2 Double Films	3
DV-57 Fresh Pak 100 Size 2 Double Films	3
DV-54 Pedo Pak 100 Size 0 Films	3
DX-58 Paper Pak 150 Size 2 Films	6
DX-57 Paper Pak 150 Size 2 Double Films	6
DX-54 Paper Pak 100 Size 0 Films	6
DX-42 Bite Chex 100 Size 3 Films	6
DX-56 Paper Pak 100 Size 1 Films	6
DX-55 Paper Pak 100 Size 1 Double Films	6

E

Econo Pak D Speed 600 Films	2
Econo Pak F Speed 600 Films	4
EnVision X-ray	12
Endodontic X-ray Positioner	11
EX-11P Paper Pak 100 Size 1 Films	6
EX-12P Paper Pak 100 Size 1 Double Films	6

(Continued on the Next Page)

Table of Contents

**Intraoral
Dental X-ray Film**
Pages 1 Through 6



**Extraoral
Dental X-ray Film**
Page 7



**Dental X-ray
Film Positioners**
Pages 8 Through 11

EnVision X-ray
Pages 13 Through 15



HDX X-ray
Pages 14 and 15

Dental X-ray Mounts
Pages 17 and 18



**X-ray
Protective Aprons**
Pages 19 and 20

X-ray Illuminators
Page 21



**Darkroom
Accessories**
Pages 22 Through 24

Numeric Index
Pages 25 and 26

Copyright©2005 by Flow X-ray Inc. all rights reserved. May not be reproduced in whole or in part by any method without express permission in writing from Flow X-ray Inc.

F

Film – Dental x-ray	
Duplicating	7
DV-58 Econo-Pak 600 Size 2 Films	2
DV-58 Value-Pak 150 Size 2 Films	2
DV-58 Fresh Pak 100Size 2 Films	2
DV-57 Value-Pak 150 Size 0 Double Films	3
DV-57 Fresh Pak 100Size 2 Double Films	3
DV-54 Pedo Pak 100 Size 0 Films	3
DV-53 Twin Pedo Pak 100 Size 0 Double Films	3
DX-58 Paper Pak 150 Size 2 Films.....	6
DX-57 Paper Pak 150 Size 2 Double Films.....	6
DX-54 Paper Pak 100 Size 0 Films.....	6
DX-42 Paper Pak 100, Size 3 Films	6
DX-56 Paper Pak 100 Size 1 Films.....	6
DX-55 Paper Pak 100 Size 1 Double Films.....	6
FV-58 Econo Pak 600 Size 2 Films.....	4
FV-58 Value Pak 150 Size 2 Films	4
FV-58 Fresh Pak 100 Size 2 Films	4
FV-57 Value Pak 150 Size 2 Double Films	5
FV-57 Fresh Pak 100 Size 2 Films	4
FV-54 Pedo Pak 100 Size 0 Films.....	5
FV-53 Twin Pedo Pak 100 Size 0 Double Films.....	4
EX-11P Paper Pak 100 Size 1 Films	6
EX-12P Paper Pak 100 Size 1 Films	6
Panoramic.....	7
Film Duplicators	23
Film Hangers, Dental.....	22
Film Mounts	17 and 18
Fixer, Liquid.....	23
Fresh Pak D Speed 100 Films	2 and 3
Fresh Pak F Speed 100 Films	4 and 5

G

Greylight Mounts.....	17 and 18
-----------------------	-----------

H

HDX X-ray	14
Hangers, Dental	22
Hangers, Identification Tabs	22

I

Identification Printer	22
Identification Printer Cards	22
Identification Tabs, Dental Hanger	22
Illuminators	21
Image Box.....	16
Index Numerical	25 and 26
Intensifying Screens	23

K

Klear-View Cardboard Mounts	17 and 18
-----------------------------------	-----------

L

Lead Free Protective Aprons	19
Loops - Bite-Wing	11

M

Mounts, Dental	
EZ Grip Plastic Mounts	17 and 18
Greylight Mounts.....	17 and 18
Klear-View Cardboard Mounts	17 and 18

O

Occlusal Film	3
---------------------	---

P

Panoramic Film	7
Paper Pak DX-58 150 Size 2 Films	6
Paper Pak DX-57 150 Size 2 Double Films	6
Paper Pak DX-54 100 Size 0 Films	6
Paper Pak DX-56 100 Size 1 Films	6
Paper Pak DX-55 100 Size 1 Double Films	6
Paper Pak EX-11P 100 Size 1 Films	6
Paper Pak EX-12P 100 Size 1 Double Films	6
Plastic Illuminator - Slimline	21
Plastic-Coated Intensifying Screens	23
Positioners	
Bite-Wing Loops	11
Cushies	11
RAPD Positioning Device	8 and 9
Self Adhesive Bite-Wing Tabs	11
Printer, Identification	22
Processor Chairside - Manual	21
Processor Solutions.....	23
Processor, Cleaner - Automatic	23
Protective Aprons	19 and 20

R

RAPD Positioning Device	8 and 9
-------------------------------	---------

S

Safelights	24
Screens, Plastic Coated Intensifying	23
Self Adhesive Bite-Wing Tabs	11
Slimline Illuminator	21
SMART Phosphor Plate Cassettes	10
SUPA.....	11

T

Tabs, Self Adhesive Bite-Wing	11
Tabs, Identification	22
Thermometers, Darkroom	22
Thyroid Collar	19 and 20
Timers, Darkroom	22
Timers, Electronic	22
Troubleshooting Tips	Inside Back Cover

X

X-ray Film, Dental	
Duplicating	7
DV-58 Econo-Pak 600 Size 2 Films	2
DV-58 Value-Pak 150 Size 2 Films	2
DV-58 Fresh Pak 100Size 2 Films	2
DV-57 Value-Pak 150 Size 0 Double Films	3
DV-57 Fresh Pak 100Size 2 Double Films	3
DV-54 Pedo Pak 100 Size 0 Films	3
DV-53 Twin Pedo Pak 100 Size 0 Double Films	3
DX-58 Paper Pak 150 Size 2 Films.....	6
DX-57 Paper Pak 150 Size 2 Double Films.....	6
DX-54 Paper Pak 100 Size 0 Films.....	6
DX-42 Paper Pak 100, Size 3 Films	6
DX-56 Paper Pak 100 Size 1 Films.....	6
DX-55 Paper Pak 100 Size 1 Double Films.....	6
FV-58 Econo Pak 600 Size 2 Films.....	4
FV-58 Value Pak 150 Size 2 Films	4
FV-58 Fresh Pak 100 Size 2 Films	4
FV-57 Value Pak 150 Size 2 Double Films	5
FV-57 Fresh Pak 100 Size 2 Films	4
FV-54 Pedo Pak 100 Size 0 Films.....	5
FV-53 Twin Pedo Pak 100 Size 0 Double Films.....	4
EX-11P Paper Pak 100 Size 1 Films	6
EX-12P Paper Pak 100 Size 1 Films	6
Panoramic.....	7
X-Ray Duplicators	23

Dental X-Ray Film Descriptive Terms

Packaging

Flow X-Ray films are available in either vinyl or paper packets. Our vinyl packets are extremely soft and flexible as well as easy to open. The paper packets have rounded corners and "memory" to stay in the shape it is contoured.

Speeds

Flow X-Ray dental films are available in "D" speed (similar to Kodak Ultra-Speed*), or "F" speed (similar to Kodak Insight*) which requires roughly half the exposure time of D speed.

Specifications

Each Flow intraoral film packet contains film sandwiched between black paper and lead foil. The film is embossed with a dot and the packets are color coded to indicate speed type and to ensure the correct side of the film is placed to the tube. Flow film is available in 5 intraoral and 2 extraoral sizes (see below), and can be processed manually or automatically.

*Ultra-Speed and Insight are registered trademarks of the Eastman Kodak Co.

Size 2
 1-1/4" x 1-5/8"
 31 x 41 mm
 DV-58 DX-58
 DV-57 DX-57
 EV-58
 EV-57

Size 0
 7/8" x 1-3/8"
 22 x 35 mm
 DV-54 DX-54
 FV-54 FV-53
 DV-53

Size 1
 15/16" x 1-9/16"
 24 x 40 mm
 DX-56 EX-11P
 DX-55 EX-12P

Size 3
 1-1/16" x 2-1/8"
 27 x 54 mm
 DX-42

Size 4
 3" x 2--1/4"
 76 x 57 mm
 Occlusal

Flow Dental X-ray Films



D Speed Vinyl Packet
 Intraoral X-ray Film Pages 2 and 3



F Speed Vinyl Packet
 Intraoral X-ray Film Pages 4 and 5



D Speed Paper Packet
 Intraoral X-ray Film,
 Panoramic And Duplicating Film
 Pages 6 and 7

"Silver D®" D Speed Dental X-ray Film



Flow Silver D is a high contrast film especially designed for today's most discerning Dentist. This higher contrast delivers greater resolution and detail.

In independent test results, Silver D delivered as much as 21% greater contrast and over 40% better resolution than other films.

Now that's an image!

What's more our unique formulation stands up to oxidized chemistry better than other films. That means you'll get more films out of each gallon of developer used.

That's what's on the inside.

Outside our vinyl packets are thinner, softer, and more flexible. Your patients will love our softer edges, your assistants will enjoy the added flexibility and easy-opening tabs!

Silver D has the same exposure settings as other D speed films and can be processed manually or automatically. For best results with your automatic processing, we recommend you use new Flow Brand "BETTER"™ Chemistry.

For more information on BETTER Chemistry see page 23

DV-58 D Speed Size 2 Adult Film

DV-58 D speed film (Ultra-speed*) Intraoral film is packaged in soft, supple vinyl packets for greater patient comfort, perfect for a broad range of x-ray exams, including anterior, posterior and bite-wing exams. DV-58 is available in three packages sizes: Econo Pak (600 pcs), Value Pak (150 pcs) and Fresh Pak (100 pcs)



Econo Pak®

600 DV-58 films per box. (4 sleeves of 150 pieces each).

Stock Number 18204

Value Pak®

150 DV-58 films per box.

Stock Number 18200

Fresh Pak®

100 DV-58 films per box.

Stock Number 18600

**THE DENTAL
ADVISOR**

++++¼



D Speed Size 2 Adult Film 2 Film Packets
DV-57

All the great image qualities of Silver D film in a double film packet. One exposure = Two films!

Perfect for referral situations or when a film duplicate is required for insurance processing. Twin D has the same exposure settings as regular Silver D, and can be processed manually or automatically.



Twin D Value Pak®
 150 DV-57 double film packets per box.
Stock Number 18201

Twin D Fresh Pak®
 100 DV-57 double film packets per box.
Stock Number 18601



D Speed Size 0 Child Film
DV-54 DV-53 2 Film Packets

All the great image qualities of Flow's Silver D in a size 0, child film size. Pedo Pak is perfect for kids ages 3 thru 8.

Pedo Pak is available in single film packets and double film packets, (Twin D Pedo Pak) Flow D speed child film has 30% less exposure than adult Silver D. Pedo Paks can be processed automatically or manually.



Pedo Pak®
 100 DV-54 films per box.
Stock Number 18235



Twin D Pedo Pak®
 100 DV-53 2 film packets/ box.
Stock Number 18236



D Speed Size 4 Occlusal Film

Occlusal film is the largest size intraoral film available, perfect for examining the arch of the maxilla and the mandible. The patient bites down on the film with the x-ray positioned either over the nose (for maxillary) or under the chin (for mandibular). The resulting x-ray captures the entire arch. This type of exam is often used to diagnose soft tissue of the cheek and lips, cartilage of the nose, and the nasal septum. Occlusal film is 57 mm x 76 mm and packaged in soft flexible vinyl packets.

25 film per box. **Stock Number 18425.**

Flow X-ray Silver D Film (D Speed) Exposure Time In Seconds

Region		65kV 10mA	65kV 15mA	70kV 7mA	70kV 10mA	70kV15mA	80kV 10mA	80kV 15MA
Maxillary	Anterior	0.25	0.17	0.22	0.15	0.10	0.12	0.07
	Premolar	0.32	0.22	0.28	0.20	0.13	0.13	0.10
	Molar	0.37	0.25	0.32	0.23	0.15	0.17	0.12
	Bitewing	0.25	0.17	0.22	0.15	0.10	0.12	0.07
Mandibular	Anterior	0.20	0.13	0.18	0.12	0.08	0.08	0.07
	Premolar	0.22	0.13	0.18	0.13	0.08	0.10	0.07
	Molar	0.25	0.17	0.22	0.15	0.10	0.12	0.07
	Bitewing	0.25	0.17	0.22	0.15	0.10	0.12	0.07

These exposure recommendations are for the use of a short cone (20cm-8"). Exposure time must be multiplied by 4 if a long cone (40cm-16") is used. For larger patients, increase time by approximately 25%. For children, small or endentulous patients, decrease time by approximately 30%. Always make sure developer chemistry is fresh.

Flow Xpress® F Speed Dental X-ray Films



As fast as any intraoral film on the market, Flow F speed films combine reduced radiation exposure with superb contrast and image resolution. Available in size 2 and 0, single and double film packets, Flow F speed takes conventional dental radiography to a new level in terms of dose minimization.

Inside: A fast film that doesn't sacrifice image quality for reduced radiation exposure! Outside, softer, thinner, more flexible vinyl packets your patients will



Comfort
you can feel!

love! Flow F speed films require approximately half the exposure time of D speed (see the exposure table at the bottom of page 5) and can be processed manually or automatically. Flow F speed has the same exposure settings as other F speed films making it easy to switch to Flow Xpress.

FV-58 F Speed Size 2 Adult Film

Flow's FV-58 is an F speed, size 2, intraoral dental film in soft vinyl packets. FV-58 requires approximately half the exposure time of DV-58. FV-58 can be used for anterior, posterior and bite-wing x-ray exams in adults, and posterior and bite-wing exams in children 9 years or older and can be processed manually or automatically.



FV-58
Econo Pak®
600 FV-58 films per box. (4 sleeves of 150 pieces each).
Stock Number 18215

Value Pak®
150 FV-58 films per box.
Stock Number 18310

Fresh Pak®
100 FV-58 films per box.
Stock Number 18620



F Speed Size 2 Adult 2 Film 2 Film Packets
FV-57

All the great image qualities of our super fast F speed Adult dental x-ray film in a double film packet.

One exposure = Two films!

Perfect for referral situations or when a duplicate x-ray film is required for insurance processing.

Flow Twin F uses half the exposure settings as our Our Silver D, and can be processed manually or automatically.

Twin F is available in our Value Pak (150 pcs) or our Fresh Pak (100 pcs).



Twin F Value Pak®
 150 FV-57 double film packets per box.
Stock Number 18410

Twin F Fresh Pak®
 100 FV-57 double film packets per box.
Stock Number 18621



F Speed Size 0 Child Film 2 Film Packets
FV-54 FV-53 2 Film Packets

All the great image qualities of Flow's Xpress F in size 0, child film size. Pedo Pak is perfect for kids ages 3 thru 8.

Pedo Pak is available in single film packets and double film packet, (Twin F Pedo Pak) Flow F Speed child film has 30% less exposure than adult F speed.

Pedo Paks can be processed automatically or manually.



Pedo Pak®
 100 FV-54 films per box.
Stock Number 18635



Twin F Pedo Pak®
 100 FV-53 2 film packets/box.
Stock Number 18636

Flow X-ray Xpress Film (F Speed) Exposure Time In Seconds

Region		60kV 7mA	60kV 8mA	65kV 7.5mA	65kV 8mA	70kV 7mA	70kV 8mA
Maxillary	Anterior	0.36	0.24	0.21	0.19	0.18	0.16
	Premolar	0.36	0.24	0.21	0.19	0.18	0.16
	Molar	0.46	0.29	0.27	0.24	0.23	0.20
	Bitewing	0.36	0.24	0.21	0.19	0.18	0.16
Mandibular	Anterior	0.27	0.18	0.16	0.14	0.14	0.12
	Premolar	0.36	0.24	0.21	0.19	0.18	0.16
	Molar	0.36	0.24	0.21	0.19	0.18	0.16
	Bitewing	0.36	0.24	0.21	0.19	0.18	0.16

These exposure recommendations are for the use of a short cone (20cm-8"). Exposure time must be multiplied by 4 if a long cone (40cm-16") is used. For larger patients, increase time by approximately 25%. For children, small or endentulous patients, decrease time by approximately 30%. Always make sure developer chemistry is fresh.

Paper Packet Film

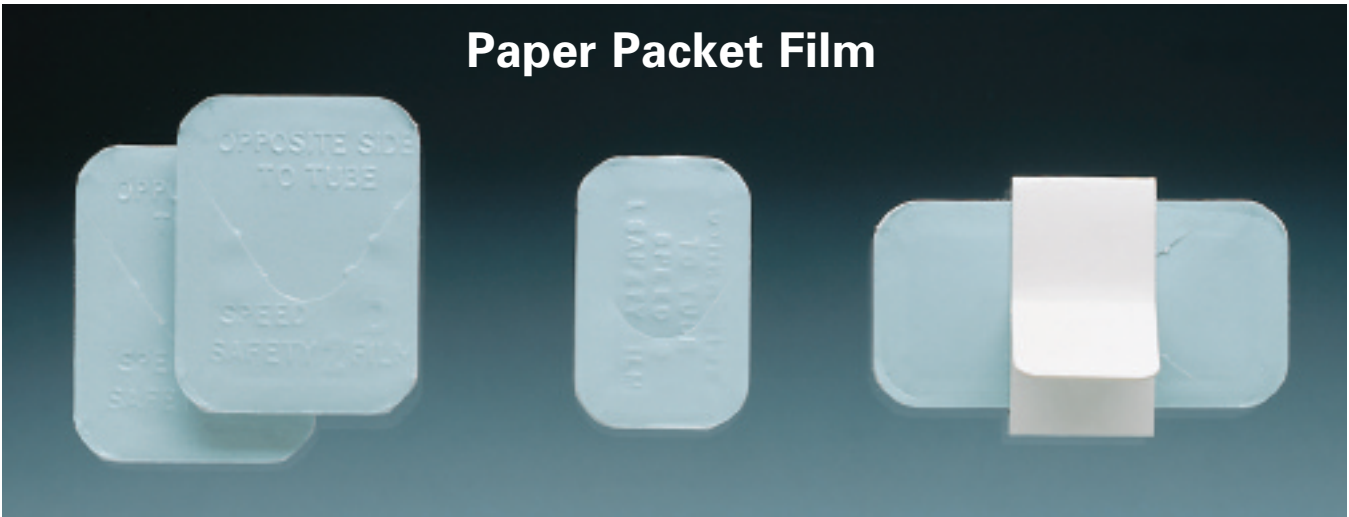

DX-58 Paper Pak® is a D speed size 2 intraoral dental film in paper packets. DX-58 has the same exposure settings and developing techniques (manual or automatic) as all other D speed films. Packaged **150 films per box.**
Stock Number 18001

DX-57 Paper Pak® is the same film as DX-58 but in **double film packets.** DX-57 uses standard exposure setting and developing techniques.
150 double film packets.
Stock No. 18101.

DX-54 Paper Pak® is a D speed size 0 child film in paper packets. DX-54 is for anterior, posterior and bite-wing exams in children from 3 to 8. DX-54 has the same exposure settings as any other D speed film and can be manually or automatically processed.

100 films per box. Stock No. 18035

DX-42 Bite Chex® Bite-Wing Size 3 D speed film is used to x-ray the coronal portion of contacting teeth. **100 films per box with tabs for film positioning.**
DX-42 Stock Number 18060



Paper Pak® Size 1 Anterior Films

Flow Anteriors are available in both D&F speeds and in single or double film packets. Anterior Films come in soft laminated paper packets for added patient comfort. **Anterior films are packaged 100 films per box, available as listed below.**

Name	Description	Stock No.
Paper-Pak DX-56	D speed Single Film Packets	18002
Paper-Pak DX-55	D speed Double Film Packets	18102
Paper-Pak FX-11P	F speed Single Film Packets	18103
Paper-Pak FX-12P	F speed Double Film Packets	18104

The Easy-Open Flow Paper Film Packet

Grasp the film packet with the thumb and index finger of your left hand. With your right hand bend the packet back until the tab pops open. Tear the tab completely back from the edge of the film and its protective layers, and slip out the film.



Green Sensitive Panoramic Film

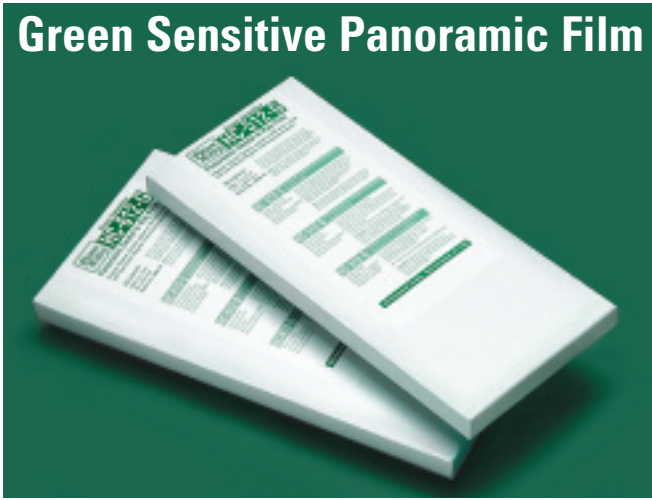

Full Speed, high contrast, orthochromatic (green sensitive) dental x-ray film available in 5 x 12" and 6 x 12" sheets.

Flow's Green Team® is ideally suited for all panoramic and TMJ imaging. The spectral sensitivity of Green Team is perfectly matched for use with all brands of green emitting, rare earth, intensifying screens. Green Team has wide surface area silver halide crystals to yield enhanced image sharpness.

Green Team 512®
5 x 12" Green Sensitive
Pano Film, 50 per box
Stock No. 18095-G

Green Team 612®
6 x 12" Green Sensitive
Pano Film, 50 per box
Stock No. 18096-G

Film	Intensifying Screen Type	Speed
Flow Green Team	Regular Green Emitting	400

Automatic Processing

Film Type	Developer
All Flow Pano Film	83°F

Safelight Requirements

The use of a GBX (or equivalent) Safelight Filter is recommended. The filter should have a 7¹/₂-watt bulb and positioned three feet from processor feed tray.

Processing

Flow Panoramic Films are compatible with all manual and automatic processing systems. Your current processing techniques do not require any change.

Blue Sensitive Panoramic Film

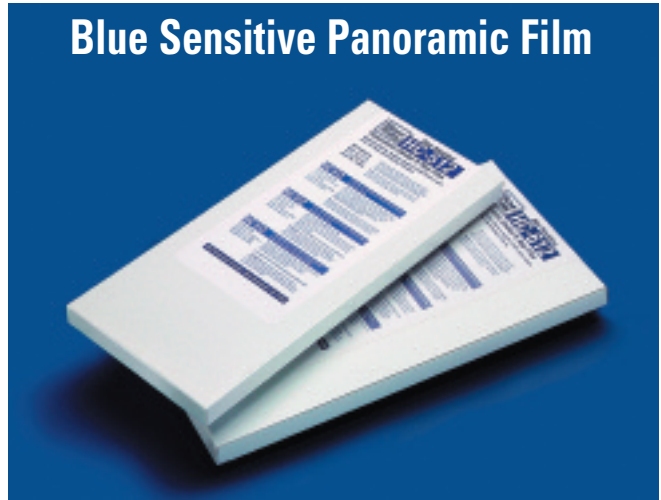

Full Speed, blue sensitive dental x-ray film available in 5 x 12" and 6 x 12" sheets.

Flow's True Blue® Panoramic film yields excellent detail with high contrast. The blue spectral sensitivity of True Blue is perfectly matched for use with all brands of calcium tungstate (blue emitting) intensifying screens.

True Blue 512®
5 x 12" Blue Sensitive
Pano Film, 50 per box
Stock No. 18095

True Blue 612®
6 x 12" Blue Sensitive
Pano Film, 50 per box
Stock No. 18096

Film	Intensifying Screen Type	Speed
Flow True Blue	Regular Blue Emitting	400

Manual Processing

Film Type	Developer	Rinse	Fix	Wash
Green Team®	72°F 7 min. 80°F 4 min.	60-85°F 30 Sec.	60-85° F2-4 min.	60-85°F 5 min.
True Blue®	68°F 5 min.	60-85°F 30 Sec.	60-85° F2-4 min.	60-85°F 5 min.

Storage

Unopened, unexposed film should be stored at temperatures at or below 70°F in a dry location, preferably between 30% and 50% relative humidity.

Handling

Film should be handled to avoid creasing, buckling and physical pressure. Handle films carefully along the edges. Avoid using hand lotions prior to handling films.



Duplicating Film DUP-512

Kopy Kat 512® is a 5 x 12 inch duplicating film. 1 sheet will reproduce 1 pano film or up to 27 intraoral x-rays. Packaged 50 sheets per box. DUP 512 can be exposed on any duplicator. Note: Kopy Kat Film is notched to identify which side should face the film being exposed.

Stock Number 18070.

Available in 6 x 12" sheets. **Box of 100. Stock Number 18071.**

The RAPD

Right Angle Positioning Device
For Dental X-ray Film

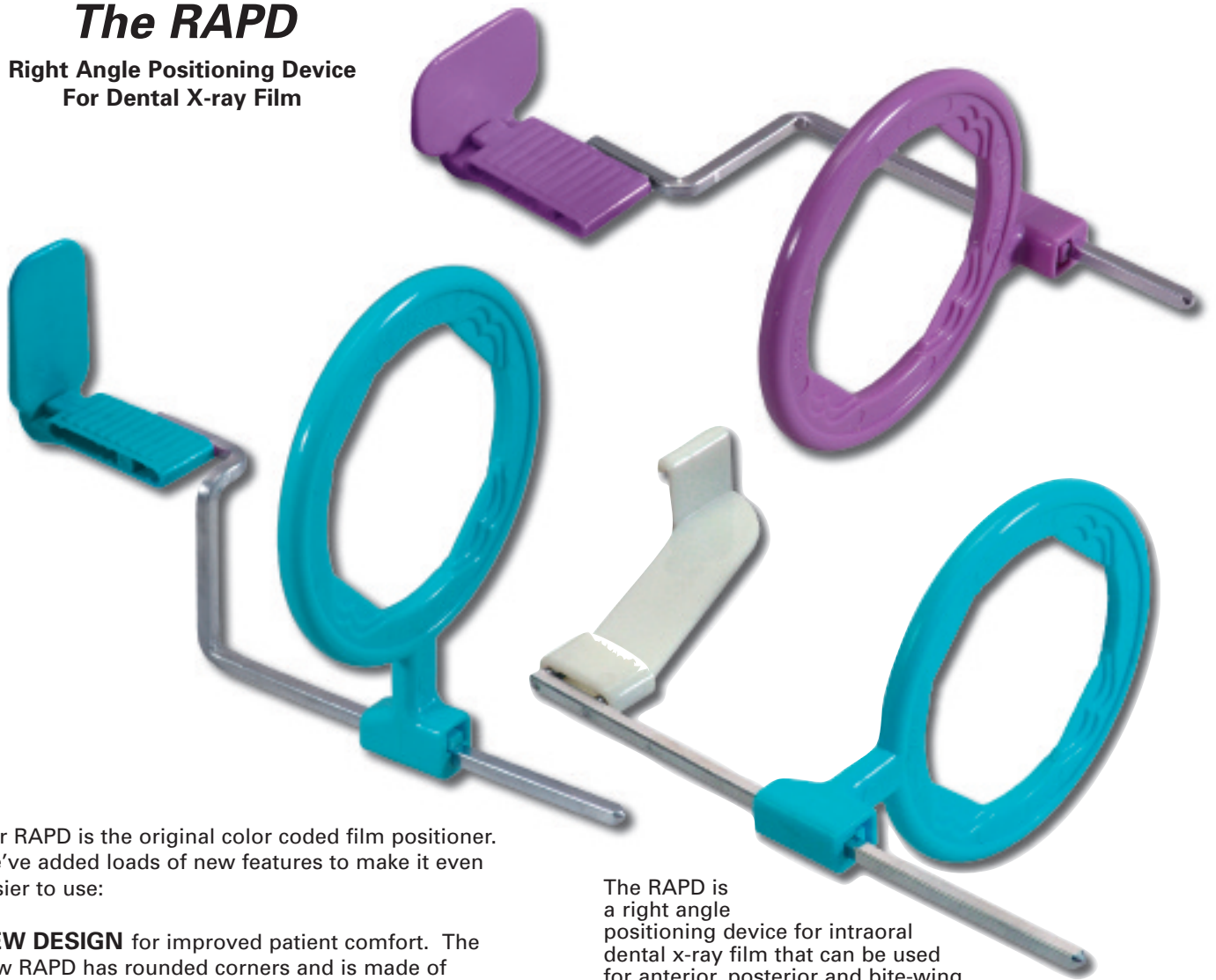

Our RAPD is the original color coded film positioner. We've added loads of new features to make it even easier to use:

NEW DESIGN for improved patient comfort. The new RAPD has rounded corners and is made of softer, lighter plastic.

NEW MATERIAL for added flexibility that makes film loading quick and easy. Our softer, more pliable material holds films more securely! Quick and Easy!

NEW COLORS See for yourself! Our new colors are fun and will bring a smile to your patient's face.

SAME OLD LOW PRICE. We tried to come up with a more expensive RAPD, but couldn't do it. The RAPD is still generally priced up to 20% lower than comparable systems (XCP).

The RAPD is a right angle positioning device for intraoral dental x-ray film that can be used for anterior, posterior and bite-wing dental x-ray exams. The RAPD can be used with any brand and size (sizes 3,2,1 and 0) of dental film. The right angle positioning system assures correct film/cone alignment preventing "cone cutting".

The RAPD's color coding makes assembly of the instruments error proof, and RAPD's are autoclavable for over 100 uses. Note that you cannot chemiclave or dry heat sterilize or use the autoclave drying cycle.

All RAPD components are interchangeable with Rinn's XCP™ System.

RAPD ordering information is on the next page.

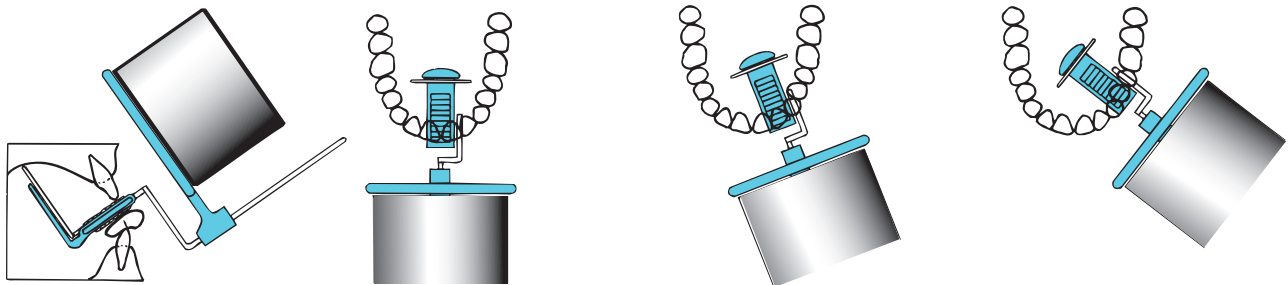

XCP is a registered trademark of Dentsply international.

RAPD Kits



As shown above, the two complete RAPD kits (408560 and 409280) are shipped in reusable blister pack trays, perfect for storing your RAPD neatly in a drawer. Additionally, step by step instructions for the RAPD are included in these kits, illustrating assembly and oral positioning.

Paralleling Kit with Bite-Wing			408560
4 Aiming Rings	4 Indicator Arms	16 Bite-Blocks	
2 Anterior/Bite-Wing	1 Anterior	4 Anterior	
2 Posterior	2 Posterior	8 Posterior	
	1 Bite-Wing	4 Bite-Wing	
Paralleling Kit without Bite-Wing			409280
3 Aiming Rings	3 Indicator Arms	18 Bite-Blocks	
1 Anterior	1 Anterior	6 Anterior	
2 Posterior	2 Posterior	12 Posterior	
Bite-Wing Kit with #2 Vertical Bite-Blocks			409250
1 Aiming Ring	1 Indicator Arm	4 Bite-Blocks	
Bite-Wing Kit with #2 Horizontal Bite-Blocks			409260
1 Aiming Ring	1 Indicator Arm	4 Bite-Blocks	
Bite-Wing Kit with #3 Horizontal Bite-Blocks			409300
1 Aiming Ring	1 Indicator Arm	4 Bite-Blocks	
Bite-Wing Kit with #0/1 Horizontal Bite-Blocks			409320
1 Aiming Ring	1 Indicator Arm	4 Bite-Blocks	

RAPD Parts Available Separately

Anterior Positioner Parts			Posterior Positioner Parts			Bite-wing Positioner Parts				
1 Anterior & Bite-wing Aiming Ring 408590	25 Anterior Bite-Blocks 408610	1 Anterior Arm 408570	1 Posterior Aiming Ring 408600	25 Posterior Bite-Blocks 408620	1 Posterior Arm 408580	Bite-wing Bite-Blocks #2 Hor. 409290	#2 Ver. 420410	#0/1 Hor. 409330	6 Each #3 Hor. 409310	1 Bite-wing Arm 409270
10 each Anterior & Posterior Bite-Blocks					408630					

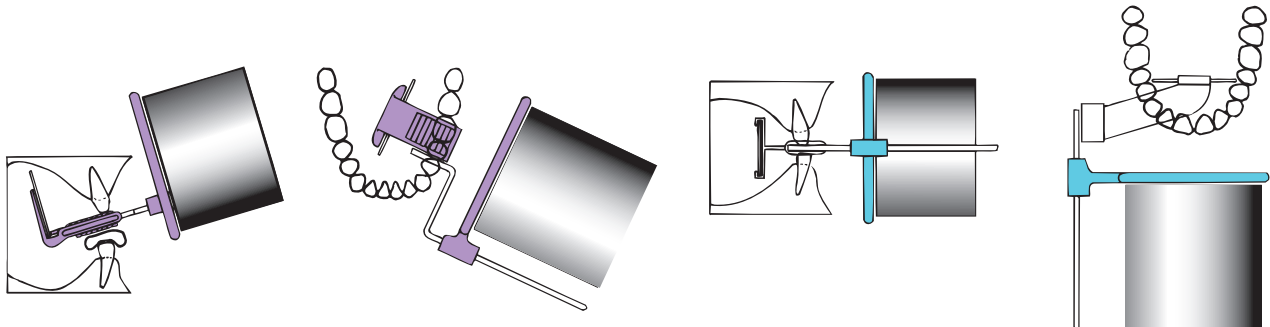

The New SMART SYSTEM For Digital Phosphor Plates



Flow X-Ray's patented new SMART system makes using phosphor plates just as easy, familiar, and convenient as film!

With the unique SMART Cassette system you and your staff will be up and running in minutes! Simply load your phosphor plates into the SMART cassettes. Each cassette, (size 2 or 0/1) is color coded to size and includes an identifying dimple and notch to insure the correct positioning of your plate. The patented SMART cassettes keep phosphor plates safe from accidental damage while also protecting them from moisture and light exposure. No more messy, expensive "baggies" for your phosphor plates!

But even more important is the SMART system! You simply clip your SMART cassette onto our universal bite block (autoclavable) and attach it to the SMART alignment device. The alignment device includes an aiming ring and positioning bar, (to keep everything in parallel alignment!)

It works just like your XCP™ or RAPD film positioner!

All parts are color coded for quick and easy set-up! SMART cassettes are single-use, economically priced for proper infection control and convenience. All other parts, including the universal bite block, are fully autoclavable!

The SMART system: So smart it's just like film...

- Load your SMART cassettes with phosphor plates.
- Snap your SMART cassette into the universal bite block and expose.
- Transport your exposed plates to your processing area. Open the cassettes and drop the used plates onto a clean paper towel or tray.
- Discard the used SMART cassettes, remove your gloves, and process your phosphor plates per manufacturer's recommendations.

After clearing the plates to erase the image, simply reload into a new, un-used SMART cassette.

XCP is a registered trademark of Rinn.

Complete Starter Kit				40854
4 Aiming Rings	4 Indicator Arms	8 Bite-Blocks	70 Cassettes	
2 Anterior/Posterior	1 Anterior 2 Posterior 1 Bite-Wing	Universal	20 Anterior 50 Posterior	
Posterior Starter Kit				40855
2 Aiming Rings	2 Indicator Arms	4 Bite-Blocks	50 Cassettes	
Posterior	Posterior	Universal	Posterior	

Replacement Cassettes, Bite-Blocks, Arms & Rings		
100	Posterior, size 2 cassettes	40852-1
250	Posterior, size 2 cassettes	40852-2
100	Anterior, size 1/0 cassettes	40850-1
250	Anterior, size 1/0 cassettes	40850-2
12	Universal bite-blocks	40870-1
24	Universal bite-blocks	40870-2
48	Universal bite-blocks	40870-4
1	Anterior Indicator Arm	40857-1
1	Posterior Indicator Arm	40858-1
1	Bite-wing Indicator Arm	40827-1
1	Anterior/Bite-wing Aiming Ring	40859-1
1	Posterior Aiming Ring	40860-1

Single Use Film Positioners



Self-Adhesive Bite-Wing Tabs Packed 500 in an automatic dispenser box, Flow's Self-Adhesive Bite-Wing Tabs easily fold down and stick to any size film.

Stock No. 15720



Made of heavy duty paper board, Flow's bite-wing loops are made to accommodate any dental film.

Adult Stock No. 15700 (500)

Adult Econo Loops

Stock No. 15725 (1,500)

Child Stock No. 15710 (500)



Cushies are pre-slit foam tubes you slip on the film to "cushion" the film edges when placed in the mouth. Cushies are perfect to place between a patient's teeth and the RAPD bite-blocks making it easier for the patient to hold the bite-block in place. 50 per box.

Stock No. 15800



Supa's are foam film holders designed to keep your film at a 90° angle to the tooth during x-rays. Perfect for parallel film positioning.

Simply place your film in the Supa retention slot, position it in your patient's mouth, aim and shoot. Supas soft cushiony material serves as an ideal

bite block, they're great for Anterior or Posterior exams using size 0,1, or 2 films. Supa's bite blocks are scored so they can be reduced if necessary. Supa's come in boxes of 100 pcs.

Stock Number 16087

Endodontic X-ray Positioner Kit

Flow's new Endodontic Positioner Kit combines the advantages of the right angle positioning technique in an endodontic format to eliminate cone-cutting when taking x-rays during endodontic procedures.



Our Endodontic Kit works just like our RAPD system except that it is designed specifically for endodontic x-rays.

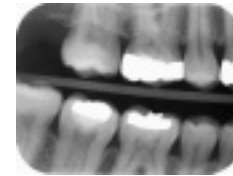

The film holder, arm and ring set up quickly and easily and are lightweight and pliable. The bite-block fits over clamps, files and dams without touching the patient's tooth. The positioner fits in all areas of the mouth and can be used with Size 1 or 2 film.



The entire kit is autoclavable and like the RAPD is available as a kit or replacement bite-blocks, arms and rings.

Endodontic X-ray Positioner Kit	40303
2 Aiming Rings 2 Indicator Arms 2 Bite-Blocks	
Parts Available Separately	
1 Aiming Ring	40010
1 Indicator Arm	40311
3 Bite-Blocks	40312

EnVisionDC

Intraoral X-ray



PROUDLY M

Designed For The Future of Dental Imaging

X-Ray imaging is typically the first, most important component of effective diagnosis treatment, planning, and good record keeping. That's why you should choose our high definition EnvisionDC as your next X-Ray.

Razor-sharp images with lower exposure to your patients! EnVisionDC delivers exceptional image quality thanks to its direct-current high-frequency technology, which delivers a short burst of energy rather than a series of waves as with conventional x-ray systems. This innovative technology reduces patient exposure time by roughly 50 percent while producing sharp, detailed images with a superior blend of grayscale and contrast. DC x-ray technology has the ability to support fluctuations in supply voltage to the x-ray head to guarantee accurate time cycles and quality imaging when compared with older AC systems. It is important however that if a voltage or image quality problem persists, that a qualified technician or electrician check the electrical supply to the X-ray machine.

Designed to work with all media

EnVisionDC offers the ultimate flexibility for your practice, it can be used with digital sensors, phosphor plates, or conventional film. You never need to invest in a new X-ray should you change your imaging media.

Intuitive, user-friendly control panel

Designed with the user in mind, the EnVisionDC control panel makes exposing x-rays as simple as 1-2-3. Simply select the tooth, media type (D or F speed film or digital), patient size and fire! Any of the pre-programmed settings can be manually adjusted and the control panel can be mounted either at the unit's base or remotely, as much as 35' away from the base unit!

Advanced self-diagnostics ensure optimal performance

EnVisionDC runs an advanced self-diagnostic check at each power-up and before each exposure. It alerts the user to any operator, utility or maintenance malfunction with an audible signal and visual error code, which identifies the problem and provides recommended corrective action, this reduces downtime and improves patient safety.

Effortless arm and tubehead positioning

The ultra-light tubehead and superior arm balance makes it a breeze to navigate the arm and tubehead into the correct patient position.

Reliability from a trusted name

Flow X-Ray has been providing reliable products to the medical and dental industry for over 75 years. Our toll-free support hotline and national service network will provide prompt response to any question or issue.

The EnVisionDC is backed by a two-year limited warranty! EnVisionDC specifications and ordering information are on page 15.



HDX X-ray



With high definition radiography you can achieve crisp, sharp, detailed results every time, regardless, of film speed or digital exposure times. HDX offers both high contrast for caries detection, and broad grayscale to meet the demands of variable tissue diagnosis.

Here's why the HDX should be your next X-ray;

Reduced Exposure Times

Power-packed Constant Potential (DC technology) reduces exposure times. In fact, this important innovation... "can reduce entrance exposure by up to 30%."

Simple, Intuitive Operator Controls

- Design makes advanced technology simple to understand.
- Fully adjustable, easy to read exposure settings (.01 - 2.0).
- Remembers your most frequently used exposure settings.
- Controls can be remote-mounted or integrated.
- self-diagnostic software with audible and visual prompts

Self-Diagnostics

- Guarantees performance every time you turn the unit on.
- Error messages, both audible and visual, are clear and pinpoint the suggested operator response.

Suspension Arm

- The horizontal reach of the standard arm will easily accommodate a two-operator pass-through design.
- Where space is limited, a short arm version is also available.
- The lightweight tubehead and stable suspension arm provide easy, accurate positioning.

Line Voltage Compensation

- Provides trouble-free operation over a wide range of image-softening voltage fluctuations.

Fast-Track Installation

- Can be quickly mounted to meet room configurations.
- Small mounting plate for pass-through installations.

Customize HDX to your practice!

- All mounted units are available with a 58" or 74" reach.
- All models are available with integrated or remote-mounted control (includes 35ft. connecting cable).
- Standard 8" round cone. Options include; 12" round, 8" & 12" rectangular.
- Mobile and portable units are available.

Best warranty in the business

Flow X-ray's HDX Intraoral X-ray is sold and warranted exclusively through authorized Flow X-ray full service dealers, and comes with a limited two year warranty.

*Compendium Report, May 1993, Vol. XIV, No. 5, "S-radiation: Potential Risks and Dose Reduction Mechanisms".

see the next page for HDX specifications.

Technical Specifications For EnvisionDC & HDX Models

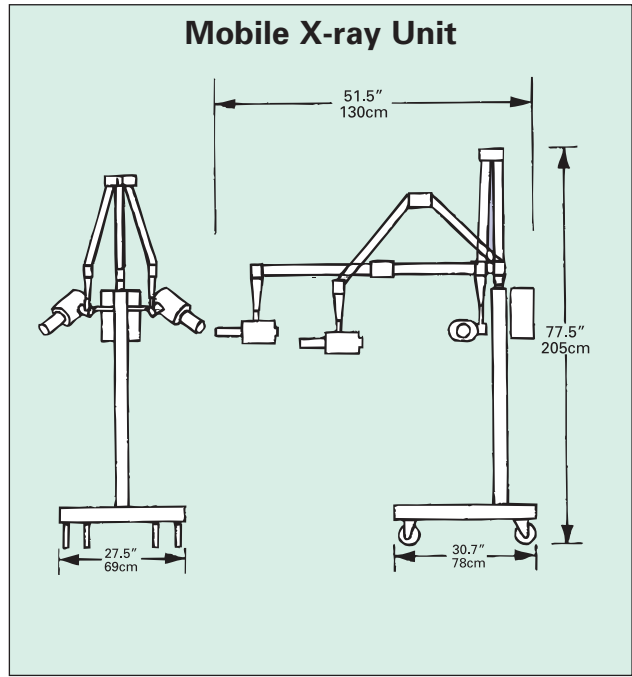
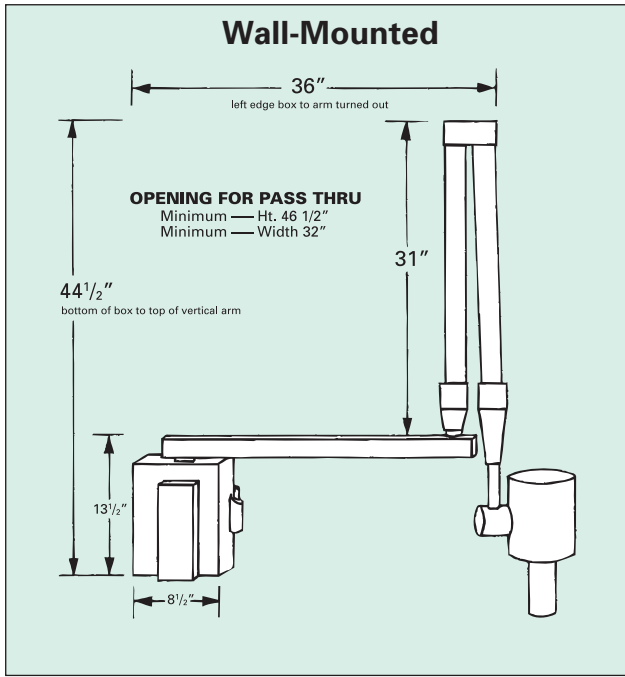

Technical Specifications

Rated Peak Tube Potential	65 kVDC
Rated Tube Current	7mA
Line Voltage Range	100-130/200-250 50/60 Hz
Line Voltage Regulation	4%
Rated Line Current	11/5.5 Amps
Exposure Time Range	0.01 to 2.00 seconds in 0.01 second increments
Accuracy	± 0.01 second
Focal Spot	0.8 x 0.8 mm
Duty Cycle	1:60 (one - 0.25 second exposure every 15 seconds)
Total Minimum Filtration:	1.5 mm aluminum equivalent

Installation Requirements	Double Stud Mounting preferred, or Single stud mount (refer to wall requirements)
Dimensions Wall Plate	12"H x 9"W Vertical travel: 50" Useful range: 44" Maximum reach 74"
Control Panel	Attached to the wall plate. Contains the microcomputer, time display and the control switches.
Remote Control Panel	Contains the control panel with 35 ft. long low voltage cable for remote mounting.
Shipping Weight	67 pounds (30.5 kg) – wall mounted unit; 135 pounds (61.4 kg) – mobile unit

Stock Numbers

X-ray unit 120V with 16" mounting plate

See the drawing above for dimensions

Description	EnVision	HDX
74" reach with integrated control panel, hand-held coiled cord exposure switch	400000	300000
58" reach with integrated control panel, hand-held coiled cord exposure switch	400001	300001
74" reach with remote control panel, includes 35 ft. of connecting cable	400003	300003
58" reach with remote control panel, includes 35 ft. of connecting cable	400004	300004

Mobile X-ray unit

See the drawing above for dimensions

Description	EnVision	HDX
Mobile X-ray unit (120V, mounted on wheeled stand)	400021	300021
Mobile X-ray unit (230-240V, mounted on wheeled stand)	400022	300022

X-ray unit options

<table border="0" style="width: 100%;"> <tr> <td style="width: 50%;">302983 8" Short Round P.I.D.*</td> <td style="width: 50%;">382953 Horizontal Arm, Short, 58"</td> </tr> <tr> <td>300310 12" Long Round P.I.D.*</td> <td>(228 cm) maximum arm reach</td> </tr> <tr> <td>302984 12" Long Round P.I.D.</td> <td>301979 Remote Exposure Switch Adapter</td> </tr> <tr> <td>302971 8" Short Rectangular P.I.D.*</td> <td>(does not include exposure switch)</td> </tr> <tr> <td>302986 8" Short Rectangular P.I.D.*</td> <td>300018 16" Center-to-Center Mounting Plate</td> </tr> <tr> <td>302972 12" Long Rectangular P.I.D.*</td> <td>300019 Back Plate Kit for opposite side of wall</td> </tr> <tr> <td>302988 12" Long Rectangular P.I.D.*</td> <td>302959 Arm Cable Replacement Kit</td> </tr> <tr> <td>365196 Tubehead Positioning Handle</td> <td>381218 8" Cone</td> </tr> </table>	302983 8" Short Round P.I.D.*	382953 Horizontal Arm, Short, 58"	300310 12" Long Round P.I.D.*	(228 cm) maximum arm reach	302984 12" Long Round P.I.D.	301979 Remote Exposure Switch Adapter	302971 8" Short Rectangular P.I.D.*	(does not include exposure switch)	302986 8" Short Rectangular P.I.D.*	300018 16" Center-to-Center Mounting Plate	302972 12" Long Rectangular P.I.D.*	300019 Back Plate Kit for opposite side of wall	302988 12" Long Rectangular P.I.D.*	302959 Arm Cable Replacement Kit	365196 Tubehead Positioning Handle	381218 8" Cone	<table border="0" style="width: 100%;"> <tr> <td style="width: 50%;">300061 12" Cone</td> <td style="width: 50%;">300072 Power Cord Kit, 120V</td> </tr> <tr> <td>300927 Remote Membrane Switch Assembly</td> <td>300071 Hand-held coiled cord exposure switch</td> </tr> <tr> <td>300412 Hand-held exposure switch holder</td> <td></td> </tr> </table>	300061 12" Cone	300072 Power Cord Kit, 120V	300927 Remote Membrane Switch Assembly	300071 Hand-held coiled cord exposure switch	300412 Hand-held exposure switch holder	
302983 8" Short Round P.I.D.*	382953 Horizontal Arm, Short, 58"																						
300310 12" Long Round P.I.D.*	(228 cm) maximum arm reach																						
302984 12" Long Round P.I.D.	301979 Remote Exposure Switch Adapter																						
302971 8" Short Rectangular P.I.D.*	(does not include exposure switch)																						
302986 8" Short Rectangular P.I.D.*	300018 16" Center-to-Center Mounting Plate																						
302972 12" Long Rectangular P.I.D.*	300019 Back Plate Kit for opposite side of wall																						
302988 12" Long Rectangular P.I.D.*	302959 Arm Cable Replacement Kit																						
365196 Tubehead Positioning Handle	381218 8" Cone																						
300061 12" Cone	300072 Power Cord Kit, 120V																						
300927 Remote Membrane Switch Assembly	300071 Hand-held coiled cord exposure switch																						
300412 Hand-held exposure switch holder																							

*Cones with square end edges for Great Britain



Image Box analog to digital x-rays

Now you don't have to purchase expensive new equipment to enjoy the benefits of digitized X-Rays, (a complete digital X-Ray system can cost you over \$60,000!)

Go Digital without the hassle and expense with the new Image Box!

A wonderful aid in treatment planning, diagnosis, and patient education, the Image Box sets up in seconds, is easy to use, and costs pennies a day to operate.

You simply load your film and the Image Box instantly digitizes the image! And if you want to save or send the image, you can connect your Image Box to a computer using a video capture card.

Quick, easy to use and affordable. The Image Box sets up quickly and easily:

- 1) Simply connect your Image Box to either a TV Monitor or computer, (computer must have either a video-in or s-video-in connection).
- 2) Insert your exposed X-Ray film into the film tray.
- 3) Push the yellow button - presto! Instant Image! The Image Box controls allow you to lighten or darken the image, too.

The Image Box sets up in minutes, and it comes with all the wiring required. Note, it does not include a monitor, TV, or video capture card and/or software.

Dimensions: H 4 1/2" W 3 7/8" L 6 1/2"
Image Box Stock Number 50209

Camera Caps

With new Camera Caps from Flow X-Ray you can use your intraoral camera to quickly and easily turn x-rays into digital images. And all for only 7 cents per patient!

Camera Caps is a single use masking device that fits easily onto most intraoral cameras. Simply place your Camera Cap onto the head of your intraoral camera and aim your camera at the x-ray, (mounted on a lit viewbox). You now have a digital image of the x-ray on your monitor! You can even store your images by adding a video capture card.

Camera Caps come in a self-dispenser of 200 Caps/box.
Stock Number 16810

Flow X-Ray Mounts

Greylight Mounts

Similar to the Rinn EZ-Tab* and ADA* style Mounts, our Greylight Mounts feature open window viewing. Films are held in place via embossed frames with raised borders that load easily and lock films firmly into place. Greylight mounts can be imprinted with custom doctor information. **Greylight mounts are available in 18 configurations.**

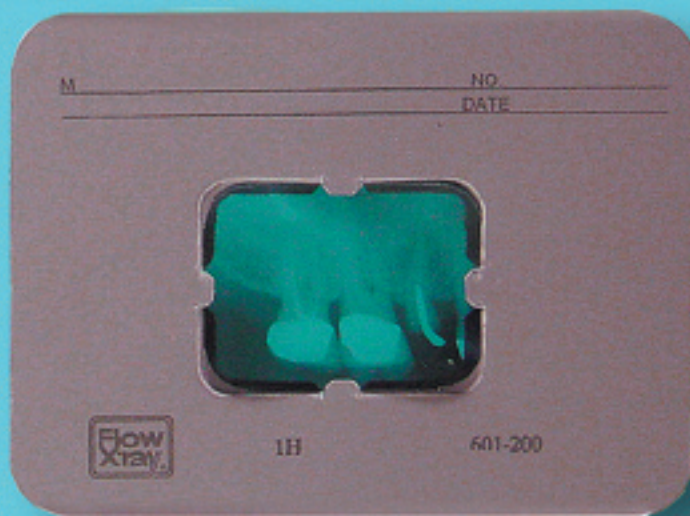

Klear-Vue Cardboard mounts

Three layers of cardboard form a recessed pocket and lip that hold film in place. Flow mounts are printed with room for patient data (name, date, notations). Mounts can be imprinted with personalized doctor information. Klear-Vue mounts are comparable to Rinn's EeZee mounts*. **Klear-Vue mounts are available in 15 different configurations.**





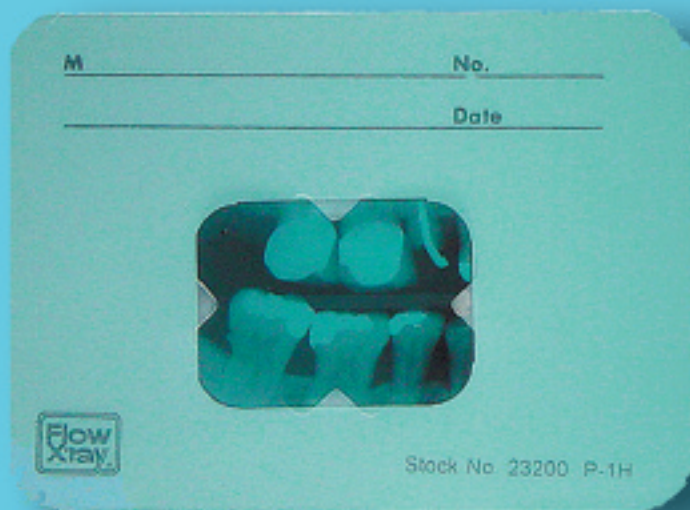













EZ-Grip Plastic Mounts

Similar to Rinn Eezeemount* plastic and Greene* TransView Mounts. EZ-GRIP Plastic mounts are made from a thin semi-rigid vinyl with die-cut tabs. Thinner than other mount styles, EZ-Grip mounts allow for compact storage of your patient records. Can be imprinted with custom doctor information. **EZ-Grip mounts are available in 15 configurations.**



Styles and stock numbers for all Flow x-ray mounts are on the following pages. All mounts are packaged 100 per box.

*ADA Mounts are a Registered Trademark of Block Drug *Rinn EeZee Mount, EZ-View, EZ Tab and Greene Transview are Registered Trademarks of Dentsply International.
*Trollmount is a Registered Trademark of Trollplast.

			Graylight Plastic Mounts	Klear Vue Cardboard Mounts	EZ Grip Plastic Mounts
	1H	1 wind horiz size 2	601-200G	25200	23200
	2H	2 wind. size 2 horiz. size 0	602-203G 402-608G	25203 25608	23203 23608
	2HBT	2 wind. horiz. B wing	702-206G	25206	23206
	4H 4H "0"	4 wind. horiz. size 2 4 wind. horiz. size 0	604-209G 404-609G	25209 25609	23209 23609
	4V	4 wind. vert. size 2	604B-510G		
	4H-2R	4 wind. horiz. 2 rows, size 2	6045-239G	25239	23259
	6H	6 wind. horiz. 2 rows, size 2	606-215G	25215	23215
	6-2V	6 wind. 4 horiz. 2 vert. size 2	606B-216G	25216	23216
	7-3V	7 wind. 4 horiz. 3 vert. size 2	607-217G	25217	23217
	8H	8 wind. horiz. 2 rows, size 2	608-219G	25219	23219
	10H	10 wind. horiz. 2 rows, size 2	610-220G		
	10 wind. B wing 10BT-"0" 10BT-"2" 10BT-"3"	size 0 size 2 size 3	610-261G 610-262G	25260 25261 25262	23260 23261 23262
	10-6V	10 wind. 4 horiz. 6 vert. size 2		25240	23240
	14-6V	14 wind. 8 horiz. - 6 v. size 2 size 0	614-225G 614B-625G	25225 25625	23225
	16-6V	16 wind. 8 horiz. 6 vert. size 2	616-226G	25226	23226
	16-6V 2BT	16 wind. 8 horiz. 6 vert. size 2 2 B wing	716-227G	25227	23227
	18-6V	18 wind. 12 horiz. 6 vert. size 2	618-228G	25228	23228
	20H	20 wind. horiz. size 2	618-230G		
	20-12H "2" 8V	20 wind. 12 horiz. size 2, 8 vert. size 1	610-270G		

NEW LEAD-FREE PROTECTIVE APRONS



*Bib Apron
without collar*

*Child size Bib Apron
with attached Collar*



*Bib Apron with
attached collar*



Panoramic Apron

The safety of lead protection without the lead or the weight.

Choose from tie-dye, tropical, hawaiian or camouflage,

Our new aprons are made of environmentally friendly lead-free, non-toxic materials, they're lighter weight and more flexible than conventional lead aprons, but have the same protective qualities!

All Flow no lead protective apron styles are 0.25mm lead equivalency protection, aprons are backed with a tear resistant cling back. Separate thyroid collars are available in the 4 fabrics shown. Please note that these four patterns are only available with the lead free feature. Our standard lead aprons available in seven colors are shown on the next page.

To Order Your Apron

To order a no lead protective apron take the stock number (shown below) and place the fabric # after it. Example: If you wanted to order a Bib Apron without a collar in the "Tye Dye" fabric your order # is **75050NL-30**.

30

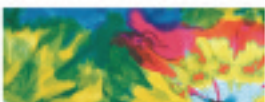

31



32



33



Description	size	stock number
Bib Apron without collar	24 X 26"	75050NL (+ color #)
Bib Apron with attached collar	24 X 26"	75051NL (+ color #)
Child size Bib Apron with attached collar	20 X 20"	75053NL (+ color #)
Panoramic Apron	24 X 27"	75061NL (+ color #)
Thyroid Collar	5 X 27"	75056NL (+ color #)

TRADITIONAL LEAD PROTECTIVE APRONS



*Bib Apron
without
collar*



*Child size
Bib Apron
with
Collar*



*Bib Apron with
attached collar*



Panoramic Apron

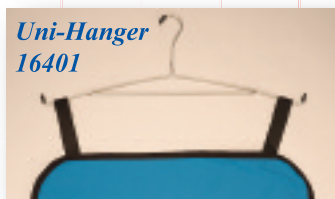

*Uni-Hanger
16401*

Traditional lead protection for your patients in fashionable styles and colors.

Flow lead protective aprons are the industry standard. Manufactured from lead rubber sandwiched between an attractive vinyl front and a tear resistant cling back, our aprons clean easily with soap and water. Made for years of heavy use, our aprons are available in the colors shown below.

All our lead aprons are .3mm lead equivalency protection, and all four styles are also available in the lead free format described on the previous page, just write "NL" after the stock number and before the color number. And for the perfect accessory to store your apron, Flow carries the Uni-Hanger which allows you to hang your apron on a hook or in a closet preventing folds which damage the lead lining.

To Order Your Apron

To order a protective apron take the apron stock number (shown below) and place the fabrics # after it. Example: If you wanted to order a Bib Apron without a collar in the "Rose" your order # is **75050-11**.



Rose Teal Medium Blue Burgundy Grey Navy Blue Beige

Description	size	stock number
Bib Apron without collar	24 X 26"	75050 (+ color #)
Bib Apron with attached collar	24 X 26"	75051 (+ color #)
Child size Bib Apron with attached collar	20 X 20"	75053 (+ color #)
Panoramic Apron	24 X 27"	75061 (+ color #)
Thyroid Collar	5 X 27"	75056 (+ color #)

Slimline® Illuminator

Made for desk or wall mounting, Flow's Slimline Illuminator series gives you the maximum viewing possibilities with an economy of space and price. The Slimline's 4¾" x 13¾" viewing area accommodates any mount up to a full series.

The Slimline comes with bulbs, 6 foot line cord and keyholes in back for easy wall mounting.

Specifications: 6½"High x 15¼"Wide x 2½"Deep
Approx. shipping weight: 3 lbs.

Description	Stock Number
steel with a white baked on finish	21730
Same as above with a stainless steel front	21731
heavy duty white plastic	21502



Econoline Illuminator

The Econoline's 14 X 17" viewing area is perfect for lateral and PA cephalometric x-rays. The Econoline is available as a single unit (14 X 17" viewing area) or a double unit (28 X 17" viewing area) and can be wall hung or recessed in the wall with our optional recessing frame.

The Econoline features 2 bulb illumination (15 watts each - 2,860 Candela per square meter), a baked on white enamel finish, a magic grip film retainer and a 6 foot line cord with a 3 prong plug.

	Height	Width	Depth	Stock #
Single	18-1/4"	14"	3-1/2"	29601
Double	18-1/4"	28"	3-1/2"	29602
Recessing Frame				
Single				29701
Double				29702



Chairside Darkroom

The unit consists of a light proof box with a safelight filter window and openings for your hands. Inside the box are cups for the developing, wash (2 cups) and fixing solutions with screw on tops to preserve solutions between use, clips to hold the processed film and a bar to hold the hanger clip while the film dries. To access the interior of the unit, you can either slide the plexiglass GBX type safelight window up or lift the top off (as shown) for complete interior access.

The Chairside Darkroom is constructed of heavy gauge plastic to withstand years of use. Replacement sleeves and cups are available.

Specifications: 12½" High x 17½" Wide x 17" Deep.

Stock Number 24230





The Flow Big Timer Our analog timer features a giant 8" diameter dial that gives you timing from 1 second to 60 minutes. It automatically shuts-off a duplicator or other electrical appliances, and has a clear buzzer signal.

Stock Number 18900

The Electronic Timer Our digital timer is a pocket sized 2 5/16" wide x 2 1/16" high x 1/2" thick. It attaches to anything: it has a spring-loaded clip that converts into a stand, a magnet for metal surfaces, and a hanging hole. Times from 100 minutes down to 1 second and emits a tone when timing period is completed.

Stock Number 18906



Dial Thermometer Calibrated from 0° - 140°F, it clips on to the tank, or floats. **Stock Number 18903**

Glass Thermometer floats in the developing tank. Thermometer is calibrated from 0° - 100°F. **Stock Number 18904**

Stainless Steel Thermometer Thermometer is calibrated for accuracy between 20° and 150° fahrenheit. **Stock Number 18905**

Digital Thermometer Registers temperatures from -40° to 300°F. Just place it in the solution and press the button. The temperature is digitally displayed on a LCD. Runs on a battery (included) and comes with a lifetime warranty. **Stock Number 19107**

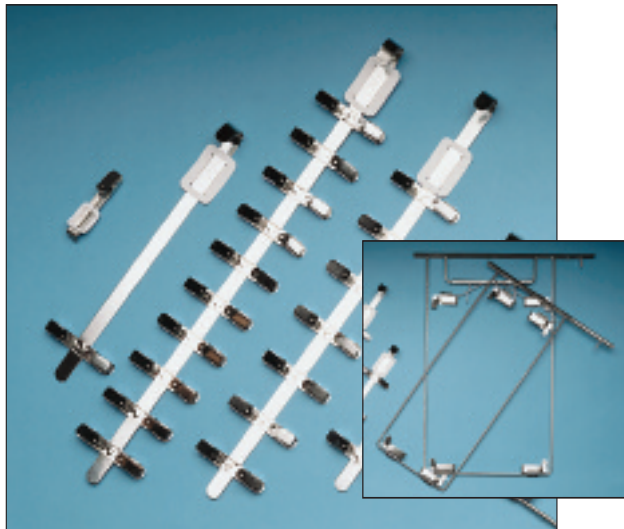

E-Z Dip® Film Developing Hangers The hanger consists of a stainless steel strip, curved at the top, to which are attached spring clips and identification tabs.

Size	Stock No.	Size	Stock No.	Size	Stock No.
2 clip (long)	16201	10 clip	16206	Single Clip	16210
4 clip (long)	16203	12 clip	16207	10 clip (long)	16215
20 clip	16204	14 clip	16208	12 clip (long)	16216
18 clip	16205	16 clip	16209	14 clip (long)	16217

Replacement Dental Hanger ID Tabs
Stock No. 14400 and **Stock No. 14401** (Single Clip)

Extraoral Film Developing Hangers These hangers are for manually developing panoramic and cephalometric x-rays.

Size	Stock No.	Size	Stock No.
5x7 inches	16300WH	5x12 inches	16501
8x10 inches	16632WH	6x12 inches	16502-SC
10x12 inches	16302WH		



ID Printers allow you to expose patient information onto extraoral film. The Flow "Auto Printer" has an adjustable exposure timer. Set the timer, insert ID card and press the exposure plate. **Stock Number 17105.**

Manual ID Printer Just insert the film and ID card, hold down the exposure plate, and release. Compatible with Kodak and Wolf ID cards. **Stock Number 17104.**

ID Printer Cards 1,000 per box. **Standard 3 x 5" Stock I.D. Cards** Printed with blanks for patient name and address. **15100 Personalized Standard 3 x 5" I.D. Cards** Same as above with customer imprint (3 line max). **15102. Double Printed Standard 3 x 5" I.D. Cards** Identification blocks printed top and bottom. **Standard 15150. Custom Imprinted 15151**

Kopy Kat® X-ray Film Duplicators

Flow X-ray offers two duplicators. The 10x12 inch surface of the 21522 is perfect for duplicating full series or panoramic x-rays, the 21520 will duplicate all films up to 6x12 inches.

Our duplicators can be used with any duplicating film. To operate the duplicators, place the film to be duplicated on the plexiglass screen with a sheet of duplicating film on top*, close the cover and set the exposure time. A red light signals you when exposure is complete.

Screen Size	Unit Dimensions			Shipping Weight	Stock Number
	L	W	H		
6 x 12"	18 1/4"	8"	6 1/4"	12 lbs.	21520
10 x 12"	18 1/4"	12"	6 1/4"	22 lbs.	21522

* Follow duplicating film instructions carefully, making sure correct side of film is face down.

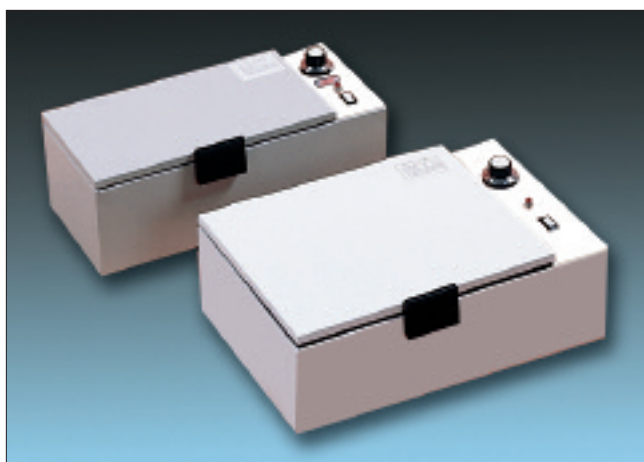

Intensifying Screens

Mounted inside your cassette, intensifying screens reduce exposure to patients and eliminate scatter radiation. **Hi-Plus:** made of calcium tungstate, provides medium speed when used in conjunction with standard blue sensitive film. 200 Speed. **Rarex BG Medium (Green Emitting):** For the same applications as Rarex BG Regular but with half the speed. 200 Speed. Use with green emitting screens.

Intensifying Screens	
Hi-Plus	Medium
10039	10765
10640	10766
10017	10748
10018	10750

Slimline Cassettes

Slimline cassettes are easy to open and close, thin for easier storage, and lightweight for easier handling.

Slimline cassettes can be used with any brand film, screen or grid.

5 x 12" (panoramic)
6 x 12" (panoramic)
8 x 10"
10 x 12"

Cassettes
11365
11366
11318
11319



Tech Tip: If you are experiencing light Panoramic or Cephalometric films exhibiting low contrast and density. If you have verified correct film type and processor function, there's a good chance the intensifying screen are worn out. Intensifying screens are mounted in the film cassette and are responsible for enhancing image quality in extraoral techniques. They do have a limited useful life and need to be replaced time to time. Flow x-ray manufactures both Green emitting and Blue emitting screens for most Panoramic and Cephalometric machines. Your distributor technician will be able to replace intensifying screens for you if required.

Better Pre-mixed Chemistry is available as follows:

2 gallons developer and
2 gallons fixer:
Stock# 24224

4 gallons developer only:
Stock# 24222

4 gallons fixer only:
Stock# 24223

Better® Pre-Mixed Developer And Fixer

Why is Better better? For starters Flow eliminated the ugly smell other chemistries have. Our fixer has a fresh, pleasant fragrance! You'll no longer dread going into the darkroom. Next we developed a formula that resists oxidation. You'll get more x-rays per gallon. Your chemistry costs just went down!

Better is specially designed to work with all roller processors and with all films.



Flow Clearing Sheets

Our 7 1/2 X 9" clearing sheets fit all intraoral and extraoral processors. Simply feed a sheet thru in the morning after machine warm-up, and as many times during the day as necessary. Flow Clearing Sheets help remove silver residue and algae, off the roller racks. Each sheet can be used up to 3 times.

Stock Number 70106

Value Chem® Concentrated Developer And Fixer

Flow Developer has a Phenidone base for a higher concentration of developer for better radiographs and slower oxidation of the solution. Flow Fixer is designed to fix a film in three minutes. A bottle of concentrate makes one gallon of working solution.

One each Developer & Fixer 24220





Swivel Safelight

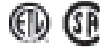

Perfect for direct spotlighting, this wall mounted unit swivels to any position. Easy to install via 2 keyholes, the Swivel Safelight includes a GBX type filter, light bulb, and a 6 foot cord with a three prong plug. Specifications: 7½" H x 6" W, Approx. ship weight 5 lbs.

Stock Number 19198



Angular Safelight

The Angular Safelight is ideal where a direct light is wanted. Easy to install via 2 keyholes, the Angular Safelight includes a GBX type filter, light bulb, and a 6 foot cord with a three prong plug. Specification: 10"H x 7½"W x 5½"D. Approx. shipping weight 5 lbs.

Stock Number 19103



Combination Safelight

This unique two-compartment unit features a safelight at the bottom and a normal incandescent room light at the top. The safelight is filtered by our GBX type filter and comes with a 6 foot cord and a 3 prong plug. Specification: 15½" Long x 10" Wide x 2½" Deep. Approximate shipping weight: 12lbs.

Stock Number 19106

The Swivel and Angular safelights are also available with an optical SENSOR that turns the safelight on automatically when the regular light is shut off (the unit can still be shut off with the on/off switch), the stock number for the Swivel safelight with the sensor feature is **19298**. The stock number for the Angular is **19203**.



Circular Safelight

Our economy model screws into any existing outlet. Made of aluminum, filtration is from a GBX type filter that is removable for bulb replacement. Specifications: 5¼"L x 4¼"D. Approximate shipping weight 5 lbs.

Stock Number 19104

Note: all Safelights should be positioned a minimum of 36" away from processing area to avoid film fogging.

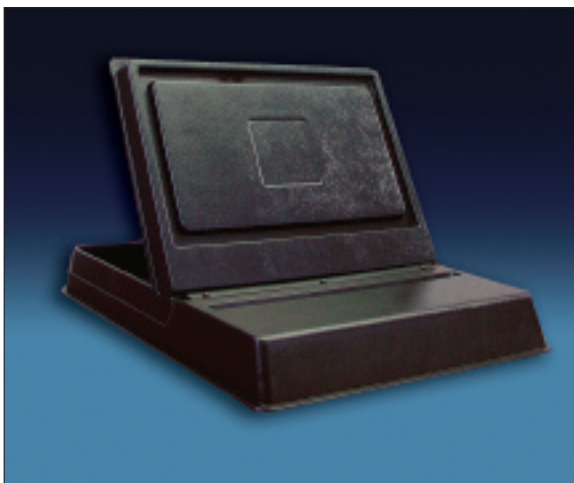

Econo-Top Film Bin

Now you can safely store your Pano Film without having to worry about accidental exposure. Flow's new Econo-Top Film Bins are your economical choice!

The Econo-Top Film Bin is made of durable plastic so it's lightweight and easy to handle. It features an easy to use lid that secures with Velcro fasteners, and comes fully assembled.

Item 25130 holds up to 300 5" x 12" or 6" x 12" films

Numerical Index

Stock Number	Page	Stock Number	Page	Stock Number	Page
10017	8	16302	22	18903	22
10018	8	16401	20	18904	22
10019	8	16501	22	18905	22
10039	8	16810	18	18906	22
10502	8	16872	11	19103	24
10503	8	16873	11	19104	24
10640	8	17104	22	19106	24
10748	8	17105	22	19107	22
10750	8	18001	6	19198	24
10765	8	18002	6	19203	24
11318	8	18035	6	19298	24
11319	8	18038	5	21104	17
11365	8	18060	6	21502	16
11366	8	18070	7	21520	23
14400	22	18971	7	21522	23
14401	22	18095	7	21607	18
15100	22	18096	7	21730	18
15102	22	18098	7	21731	18
15150	22	18101	6	23200	18
15151	22	18102	6	23203	18
15700	11	18103	6	23206	18
15710	11	18104	6	23209	18
15720	11	18200	2	23215	18
15800	11	18201	3	23216	18
16087	11	18204	2	23217	18
16201	22	18215	4	23219	18
16203	22	18235	3	23225	18
16204	22	18236	3	23226	18
16205	22	18310	4	23227	18
16206	22	18410	5	23228	18
16207	22	18425	3	23239	18
16208	22	18600	2	23240	18
16209	22	18601	3	23260	18
16210	22	18620	4	23261	18
16215	22	18621	5	23262	18
16216	22	18635	5	23608	18
16217	22	18636	5	23609	18
16300	22	18900	22	24220	23

Stock Number	Page	Stock Number	Page	Stock Number	Page
24222	23	40855	10	400004	15
24223	23	40857	10	400021	15
24224	23	40858	10	400022	15
24230	21	40859	10	408560	9
25130	24	40860	10	408570	9
25200	18	40870	10	408580	9
25201	18	50209	16	408590	9
25203	18	70106	23	408600	9
25204	18	75050	20	408610	9
25206	18	75051	20	408620	9
25209	18	75053	20	408630	9
25215	18	75056	20	409250	9
25216	18	300000	15	409260	9
25217	18	300001	15	409270	9
25219	18	300003	15	409280	9
25225	18	300004	15	409290	9
25226	18	300018	15	409300	9
25227	18	300019	15	409310	9
25228	18	300021	15	409320	9
25239	18	300022	15	409330	9
25240	18	300061	15	420410	9
25260	18	300071	15	601-200	18
25261	18	300072	15	602-203	18
25262	18	300310	15	604-209	18
25608	18	300412	15	604-239	18
25609	18	300927	15	604-510	18
25625	18	301979	15	606-215	18
30000	15	302959	15	606-216	18
30001	15	302971	15	607-217	18
30003	15	302972	15	608-219	18
30004	15	302983	15	610-220	18
30021	15	302984	15	610-261	18
30022	15	302986	15	610-262	18
40010	11	302988	15	610-270	18
40303	11	365196	15	614-225	18
40311	11	381218	15	614-625	18
40312	11	382953	15	616-226	18
40850	10	400000	15	618-228	18
40852	10	400001	15	618-230	18
40854	10	400003	15	716-227	18

Intraoral Film Quick Reference Troubleshooting Guide

Most problems associated with intra oral dental film have to do with processing. Processing is the action of taking film out of the packet, (once it has been exposed), and running it through developer, fixer, wash, (water) and finally drying.

Problem	Causes and Cures
Weak or washed out image	This is caused by spent or exhausted developer solution.
Spots on film	Usually caused by cross contamination; developer splashes onto fixer or vice-versa. Also water spots from improper washing and/or drying may occur.
A bright image lacking contrast or definition	Usually caused by underexposure of film or not enough time in the developing solution. Also you should check to see if developing solution is spent or exhausted.
Bright transparent area on film	Generally caused by film being left in fixer too long. A very dark image may be caused by film being over exposed, or left too long in the developing solutions.
Transparent spots in the film	Usually the result of fixer getting onto the film prior to going into the developer. Another cause may be air bubbles on the film during developing.
Part of the image is very dark	Film was partially exposed to light during the process.
Film peeling off, scratchy white particles	May be caused by very high temperatures in the developer, fixer, or wash water. Another potential reason could be improper film storage, (high heat or humidity) or film is past it's expiration date (see the side of film box for expiration date.).

Darkroom / Processing Tips			
Darkroom temperature should be between 10°C and 20°C (50°F to 68°F) and humidity between 30-50%.	Be sure your safelight uses a GBX type filter, a frosted 15-watt bulb and is no less than 1.2 meters, (or 4 feet) away from your film handling area.	In the event film appears fogged or image is light, check for light leaks: Turn out all the lights, stand in the middle of the room for five minutes. After 5 minutes, if you can make out the outline of objects within the room, then the room is not properly light proof.	Developing solutions, (fixer and developer), should be replenished daily. Oxidation causes chemistry to break down even when not in use.

For further assistance, please contact your local dealer or Flow X-Ray customer support at 800-356-9729 or on the web at www.flowxray.com

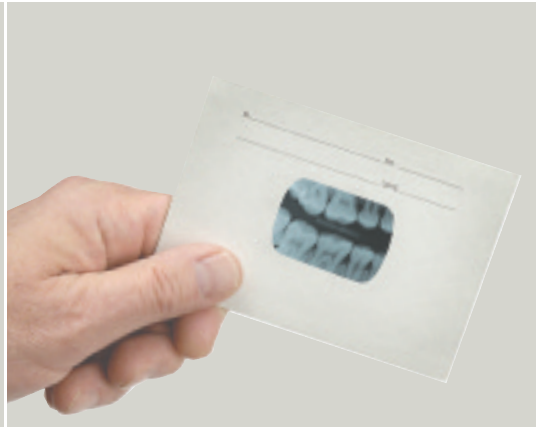

Flow X-ray Corporation
100 West Industry Court
Deer Park, New York 11729
Telephone: (631) 242-9729
Fax: (631) 242-1001
Toll Free: (800) 356-9729
info@flowxray.com
www.flowxray.com