

# DURAY<sup>®</sup> EXTRAORAL X-RAY Series

Experience the ultimate flexible 2D/3D extraoral solution you've always envisioned for your practice.





## DURAY® 2D

The Duray® 2D is the latest addition to Beyes® gamma line of panoramic platforms, providing nine specialized panoramic programs, an integrated touchscreen, and convenient future proofing. In an era where remote upgrades hold growing significance, the Duray® 2D platform is intentionally designed for easy remote enhancement. Drawing from the well-established Duray® 3D platform in the market, the Duray® 2D introduces unmatched innovation to the world of panoramic imaging.

### Smart Backlight

Duray® 2D easily communicates status through integrated coloured backlights.

### Integrated Touchscreen

For smooth and easy to use acquisition.

### Advanced Sensor

Advanced sensor with excellent sensitivity resulting in high detail images at low dose rates.

### Panoramic Bitewing

Time efficient, preventive scan is a perfect alternative for patients who cannot tolerate intraoral bitewings.

### High Definition and Eco Programs



The inclusion of both adult and, more importantly, child programs is crucial for ECO low-dose examinations, enabling high diagnostic image quality for both overview and demanding diagnostic tasks.

## New Dynamic and Automatic Image Focusing

Thanks to the innovative smart sensor-software interface technology, the panoramic images are automatically focused at every exposure, adjusting for eventual patient mispositioning or movement artifacts.

- 1 Child Panoramic
- 2 Adult Panoramic
- 3 Bitewing
- 4 Adult Panoramic
- 5 Adult Half Dentition Left

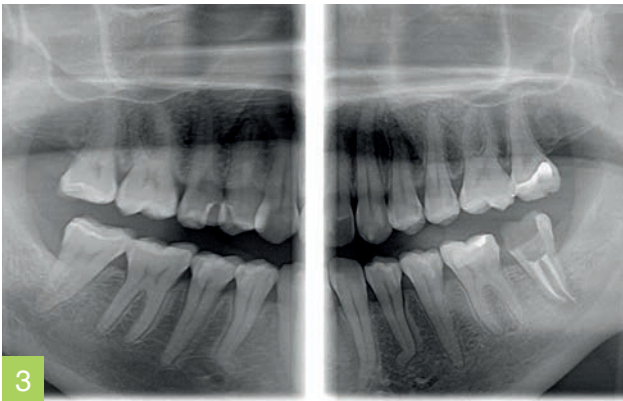

## DURAY® 2D CEPH

The most versatile 2D platform in our Extraoral gamma line has arrived: the Duray® 2D Ceph. With its exceptional panoramic and one-shot cephalometric capabilities, it can be effortlessly upgraded to 3D at any time. Elevate your clinic to a whole new level whenever you choose, and attain a comprehensive 3-in-1 solution by swiftly and easily adding the 3D module. Select your preferred ceph size - 18x24cm or 30x24cm - and achieve outstanding images, all thanks to the state-of-the-art CSI-CMOS flat panel sensor.

Its elegant and compact design, smart backlight and touchscreen, automated sensor movement, and ergonomic patient positioning provide the ideal solution for modern clinics.

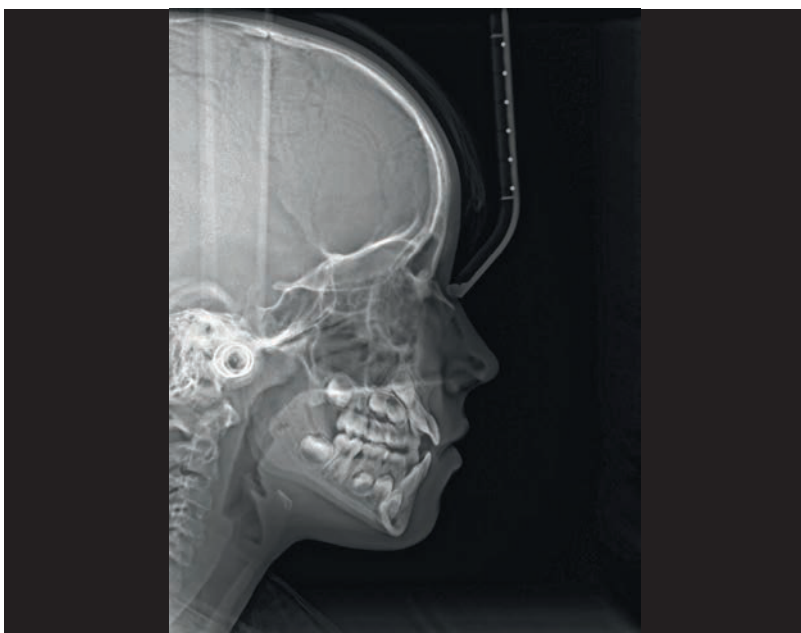
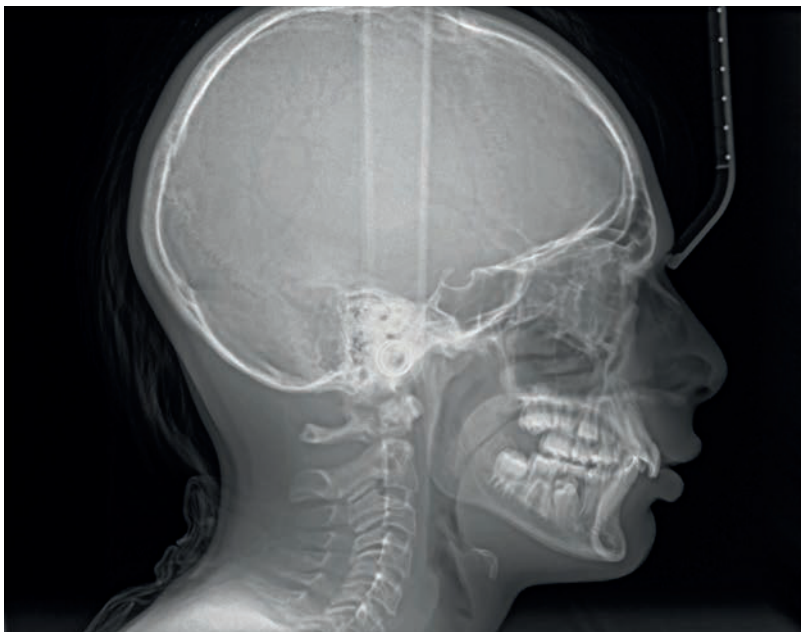



## One Shot Ceph

High performance and instant images with the CSI-CMOS One-shot flat panel.



## Advanced Sensor

Advanced sensor with excellent sensitivity resulting in high detail images at low dose rates.

## Smart Backlight

The integrated lights on the back of the unit serve a dual purpose. They indicate the function status to the operator while also providing a calming effect for the patient.

# DURAY® 3D & 3D Ceph

Duray® 3D is a complete, compact, and fully upgradable 3D CBCT Panoramic and Cephalometric system. It covers a gamut of applications - such as endodontics, periodontology, surgery, implantology, and orthodontics - providing everything you need for your daily practice.

It's a flexible solution that can be upgraded to one-shot cephalometry any time.



## Diagnostic Applications

Volume [cm]	Children	Endo	Surgery	Perio	Implant	Ortho	TMJ	Sinuses
5 x 6.5		✓		✓	✓			
6 x 10		✓	✓	✓	✓			
7 x 6.5		✓		✓	✓			
8 x 6.5	✓		✓	✓	✓	✓		
7 x 10		✓	✓	✓	✓			
8 x 10	✓	✓	✓		✓	✓		✓
10 x 6.5			✓	✓	✓	✓	✓	
10 x 10			✓		✓	✓		✓



Ergonomic handles, headrest, and chinrest for comfortable positioning and perfect stability during the exam.

The intuitive, integrated touchscreen enables straightforward selection of your preferred program - Panoramic, Ceph, or 3D. It provides a choice of eight different fields of view, ranging from 5x6.5cm to the largest at 10x10cm.



The smart backlight will indicate when the unit is ready to take the X-ray and simultaneously provides a calming environment for your patient.

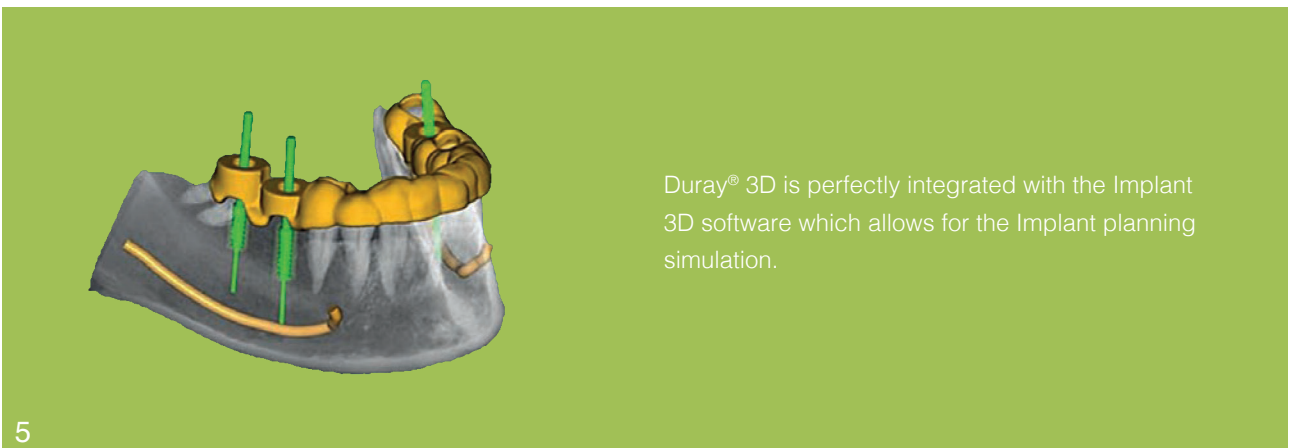

Duray® 3D is perfectly integrated with the Implant 3D software which allows for the Implant planning simulation.



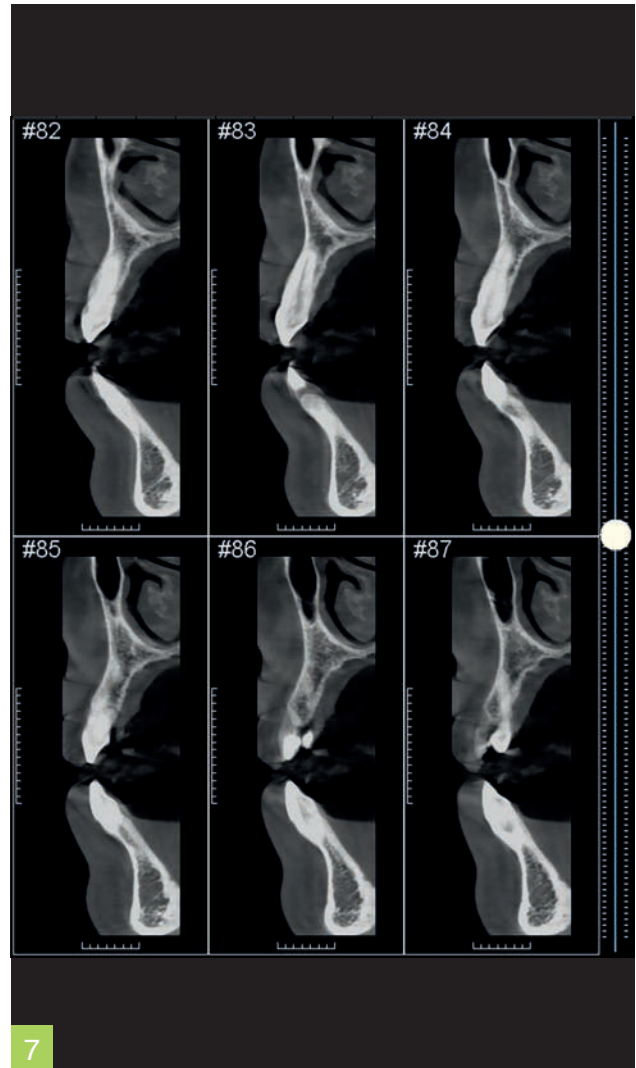

1 10x10 HD volume for Sinuses Evaluation.

2 5x6,5 HD small volume for endodontic and periodontic evaluations.

3 7x6,5 volumes for local evaluations of periodontal diseases or implants osteointegration checks.

5 Example of multiple Implant Planning.

6 10x10 HD for a full mouth evaluation.

7 Cross sections – evaluation of the cortical bone.

8 Examples of Single and Multiple Implant Planning.

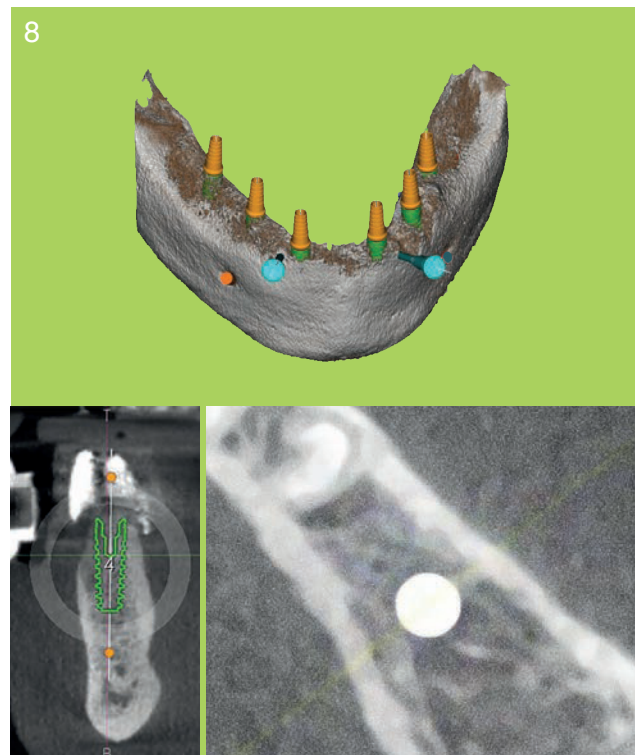

# Highlights and Benefits



## Touchscreen Next To Patient

Being able to adjust all parameters while positioning the patient is advantageous for a seamless workflow - providing ergonomics and speed while acquiring images and processing them for diagnosis.

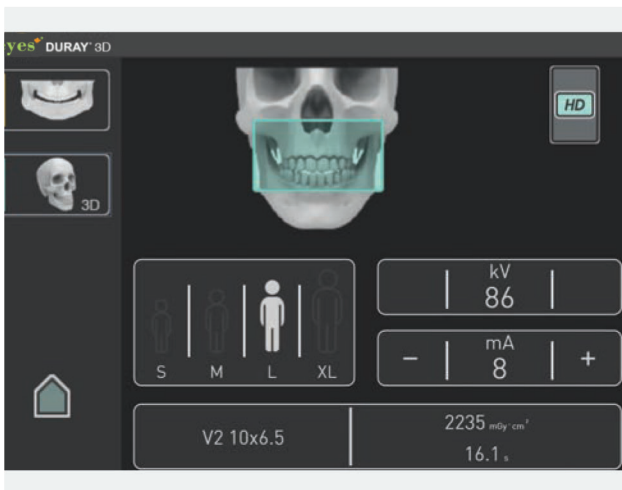

## Mirroring

Remote control of the unit from the PC screen allows for the adjustment of settings without the need to constantly move back and forth to the patient.



## Quick Positioning

Frontal mirror, laser beams, and easy positioning picture-guide on the touchscreen are available to ensure the patient's head is in the optimal position to capture the desired region.



## Quick Cephalometrics

When you need to take a Cephalometric image, patient positioning is even faster. A one-shot CEPH image is acquired in less than 1 second, preventing patient movement and ensuring the highest image quality.



## Smart Backlight

The backlights not only inform the operator of the unit status from a distance, but also provides a calming environment for the patient.



## Safe & Easy

Thanks to the automatic sensor rotation, there's no need to reposition or detach the sensor when switching between Panoramic, 3D, or Cephalometric modes. This effortless process eliminates the potential risk associated with manually handling a costly sensor.

# Highlights and Benefits



## Comfortable Operation

Once the patient is positioned, simply hold the exposure button.

The smart backlight guides you through the progress of image acquisition and automatically communicates it to the software.



## Instantly Upgradeable

The unit can be installed with or without the OneShot ceph arm.

It is ready for field upgrade for Cephalometric arm later.



## Plug & Play Concept

Duray® Series is ready to use immediately, as it comes with a pre-installed tower computer, or with an optional laptop in the case of Duray® 2D/2D Ceph, and with the latest imaging software - DURAY DG Suite by Beyes®.



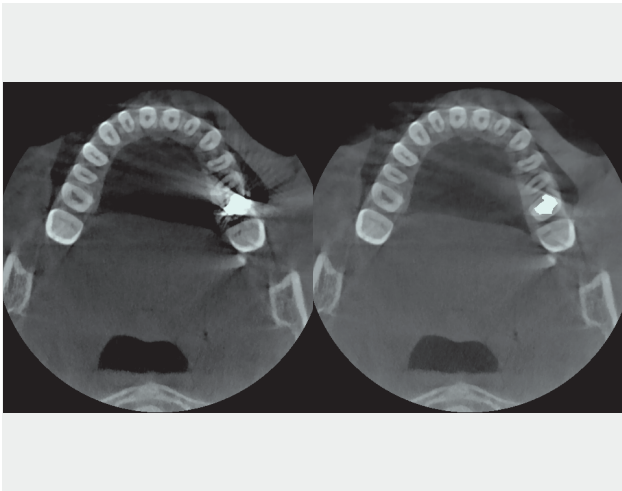

## Automatic Metal Artifact Reduction (AMAR)

Metal artifacts distort in CBCT imaging. Duray® 3D automatic metal detection reduces those effects to a minimum.

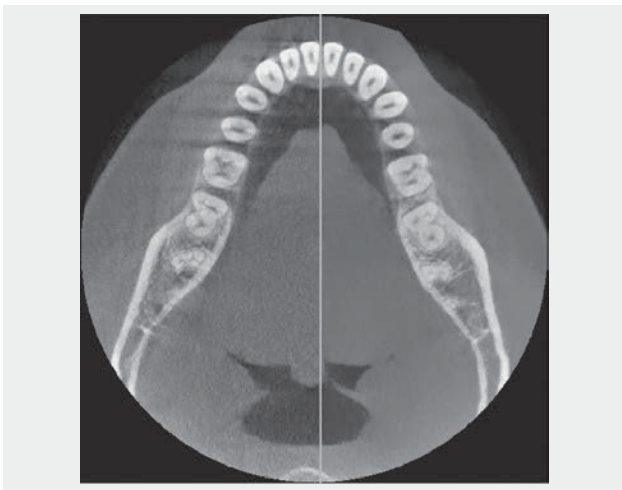

## Automatic Noise Reduction (ANR)

The presence of noise in 3D images can disturb the visibility, especially in ENDO applications. Beyes® ANR technology performs automatic reduction of noise.



## Advanced Technology for the Best Results

The latest on-board technology has been used to achieve the highest level of image detail, and the advanced kinematic motion allows for smooth and quiet unit operation.

## Duray® Series

**Comments** 3 in 1 solution: Panoramic 2D and 3D CBCT, Panoramic 2D and 3D CBCT with Ceph One shot, Panoramic 2D, Panoramic 2D Cephalometric One Shot (upgradable to 3D).

<b>3D</b>	3D Programs	23 programs: adult full, child full, adult and child upper and lower jaw, adult and child sinuses, surgical and implant volume front, left and right, hemi-arc left and right, upper and lower, ENDO volume in 6 different positions, TMJ right and left.
	Volume size 3D	8 volumes: 5x6.5, 7x6.5, 6x10, 7x10, 8x6.5, 8x10, 10x6.5, 10x10 (in cm)
	Voxel size	80 µm, 190 µm
	Exposure time 3D	12.4 – 13 s (STD mode)   16.1 – 16.9 s (HD mode)

<b>Panoramic</b>	Panoramic Programs	9 programs: adult pano, child pano, dentition, Panoramic bitewing, TMJ, sinuses, half dentition left, half dentition right, anterior teeth.
	Pixel Size	99 µm
	Exposure time 2D	4.6 – 14.2 s (STD mode)   3.2 - 9.9 s (ECO mode)

<b>Cephalometric</b>	Ceph Programs	LL 30x24, LL 18x24, AP, PA, Carpus
	Ceph Image Size	240x300 mm, 240x180 mm
	Exposure time Ceph	0.2 – 4.0 s

**Patient Sizes** 4 sizes small, medium, large and extra-large

## Software - DURAY DG Suite

**Additional viewers** Included 10 workstation licenses with optional extension

### DICOM Store for PACS

**DICOM Worklist** Optional DICOM upgrade of Software license

### DICOM Print

**DICOM image import / export** Yes, included

**Print for 2D images** Yes, included

**TWAIN** Yes, included

**3rd party Patient management software links** Yes, included

**Import/Export of 2D Images** Yes, included

**Import/Export of 3D Images** Yes, included, DICOM standard

**Export with viewer on USB/CD/DVD** Yes, included

**Supported image formats** DICOM, DICOM raw image, JPG, BMP

**Implant planning softwares** Yes, optional DURAY 3D Implant Planning Software available

**Other supported products** Compatible with all the DURAY Imaging platforms such as: DURAY Art Plus Series

## Ergonomics

<b>Patient position</b>	Standing or sitting
<b>Wheelchair accessible</b>	Yes
<b>Positioning</b>	against mirror, 3 aiming light beams, temporal support

## Dimensions & Installation

<b>Weight</b>	109 kg without ceph, 137 kg with ceph
<b>Footprint</b>	Unit without cephalometric arm 97.5 cm x 117.5 cm x 222 cm Unit with cephalometric modality 189 cm x 117.5 cm x 222 cm
<b>Fixation</b>	wall fixation and floor fixation with baseplate
<b>Power supply</b>	230 V $\pm$ 10%, 115 V $\pm$ 10%, 50/60 Hz
<b>Computing system</b>	Included, with preinstalled reconstruction and viewing software and patient database. Monitor not included
<b>Connectivity</b>	Duray® 3D/3D Ceph: 2 ethernet cables Duray® 2D/2D Ceph: 2 ethernet cables + USB 3.0 adapter

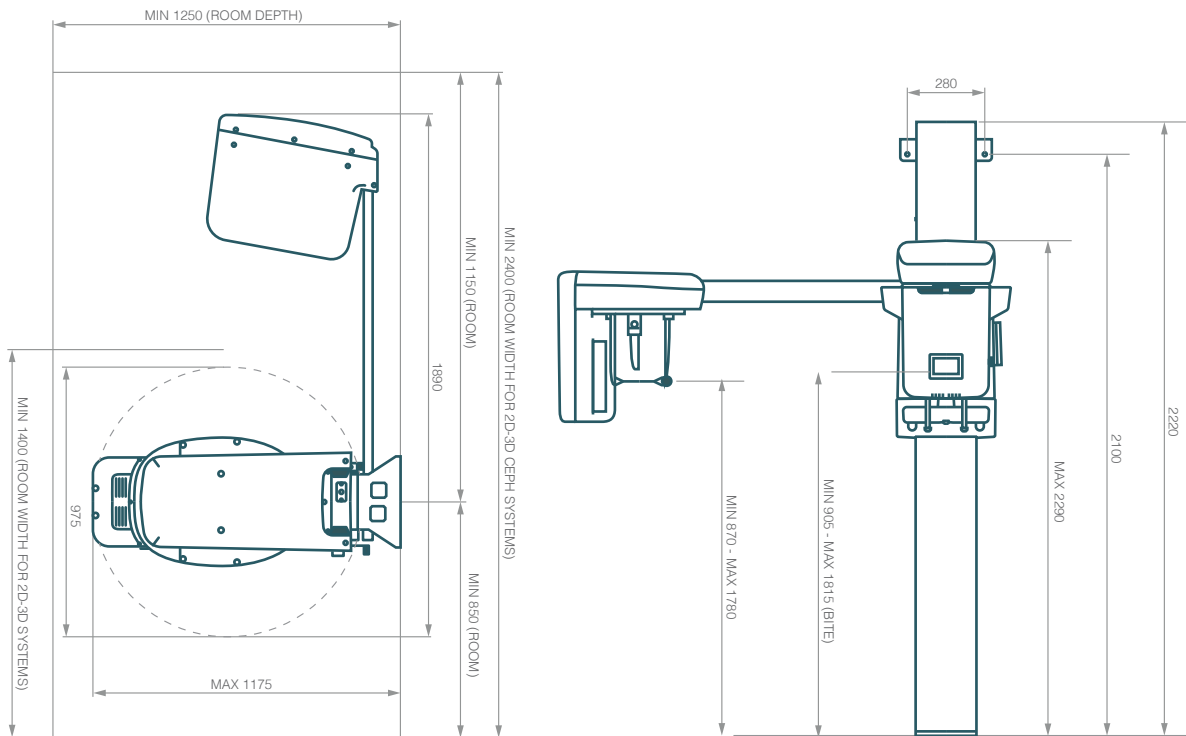



Beyes is the largest Canadian dental handpiece manufacturer with its corporate office located in Toronto. By taking advantage of the highly educated workforce and well-established manufacturing chain in Southern Ontario, Beyes has revolutionized the dental industry with groundbreaking advancements for precision dental instrumentations.

Our Vision: To create “The Next Standard” for dentistry.

## Comprehensive Product Portfolio



Intraoral imaging



Extraoral imaging

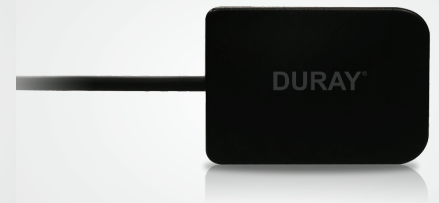

Intraoral sensors

### Your Dealer for Beyes Products



**Beyes Dental Canada Inc.**  
23-595 Middlefield Road  
Scarborough, Ontario, M1V 3S2  
Canada

**Tel:** 1-855-603-1888  
**Email:** info@beyes.ca  
**Web:** www.beyes.ca



**Lotus NL B.V.**  
Koningin Julianaplein 10, le Verd,  
2595AA, The Hague,  
Netherlands



Scan the QR code for more information

Printed in Canada  
Document #: ENB051R2  
09.27.2024

© Beyes Canada Inc 2024. All Rights Reserved.  
Specifications are subject to change without notice.  
All brands are holders of their respective trademarks.  
All Beyes products are manufactured in strict compliance with Health Canada regulations ensuring quality. Manufacturing facility is ISO 13485 certified under the Medical Device Single Audit Program (MDSAP).