

Obturation Success for Everyone



BioRoot™ Flow

Bioceramic Root Canal Sealer



BioRoot™ Flow makes obturation easy

Ready-to-use syringe

- ▶ Easy and fast: no preparation time
- ▶ Consistent viscosity all the time
- ▶ Warm or cold obturation

Direct intra-canal delivery

- ▶ 21 gauge bendable tip
- ▶ Ensures adaptation to all root canals
- ▶ Limits the risk of overfilling



Keep your technique

- ▶ Keep your preferred obturation technique
- ▶ Or shift to easy single cone technique with efficient results⁽¹⁾

Highly radiopaque

- ▶ >5 mm Al radiopacity
- ▶ Easily visible on X-Rays

(1) Internal data. Implantation endodontic test June 2020

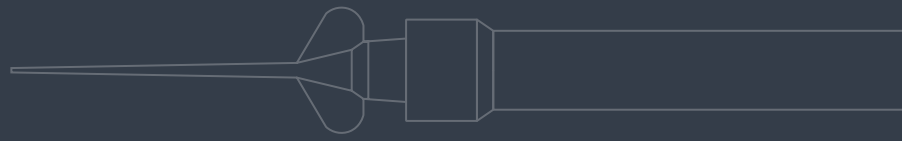

Easy extrusion

- ▶ Limited plunger resistance⁽²⁾
- ▶ Anatomic finger grip for improved syringe handling
- ▶ Easy and precise delivery in mouth
- ▶ More comfortable and user-friendly⁽²⁾

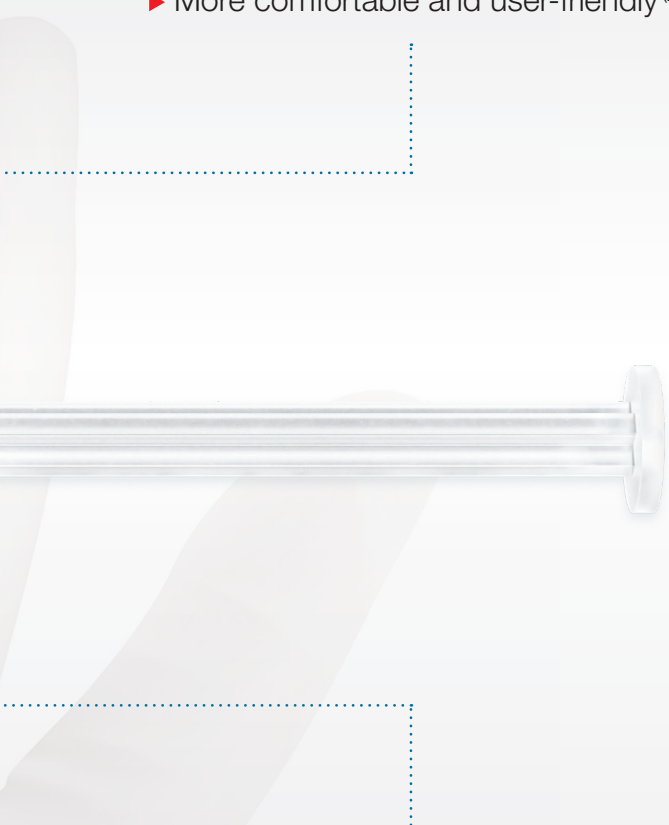

Easily retreatable⁽³⁾

- ▶ Easy and fast to remove if necessary
- ▶ Use hand files or rotary NiTi files

Technical Insights

Innovative tip allows direct & precise placement in the root canal

- Flexible tips allow bending and access to all root anatomies
- Precise 21-gauge diameter for optimal delivery limiting the risk of going too deep

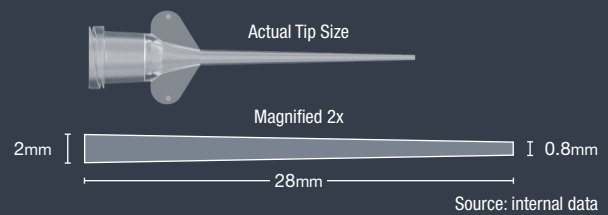

(2) Less force needed for product extrusion

- BioRoot™ Flow requires only 30N
- Product extrusion is easy and comfortable

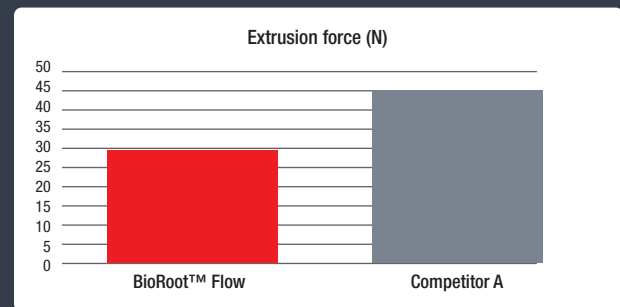

(3) Easy and fast removal from root canal

- BioRoot™ Flow is removed to working length in less than 10 min

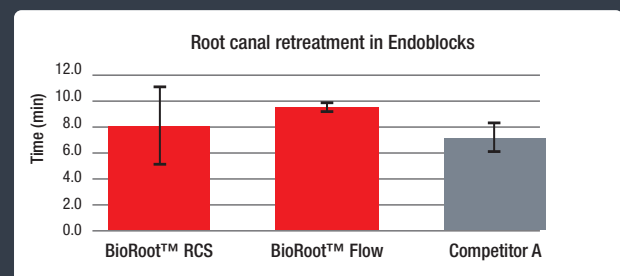

BioRoot™ Flow for successful obturation

No Shrinkage⁽¹⁾

- ▶ Resin-free formulation
- ▶ Hermetic seal of the root canal⁽²⁾
- ▶ Allows best results even with single cone technique⁽³⁾

Limits bacterial growth

- ▶ High pH 8.5-11.5
- ▶ Creates an alkaline⁽⁴⁾ environment, inhibiting bacterial growth

Penetrates radicular canals

- ▶ Without the need for compaction
- ▶ Hydrophilic sealer that seeks residual water in accessory canals & tubules⁽⁵⁾
- ▶ Excellent flowability of 23 mm and low solubility of 1.5%⁽⁶⁾

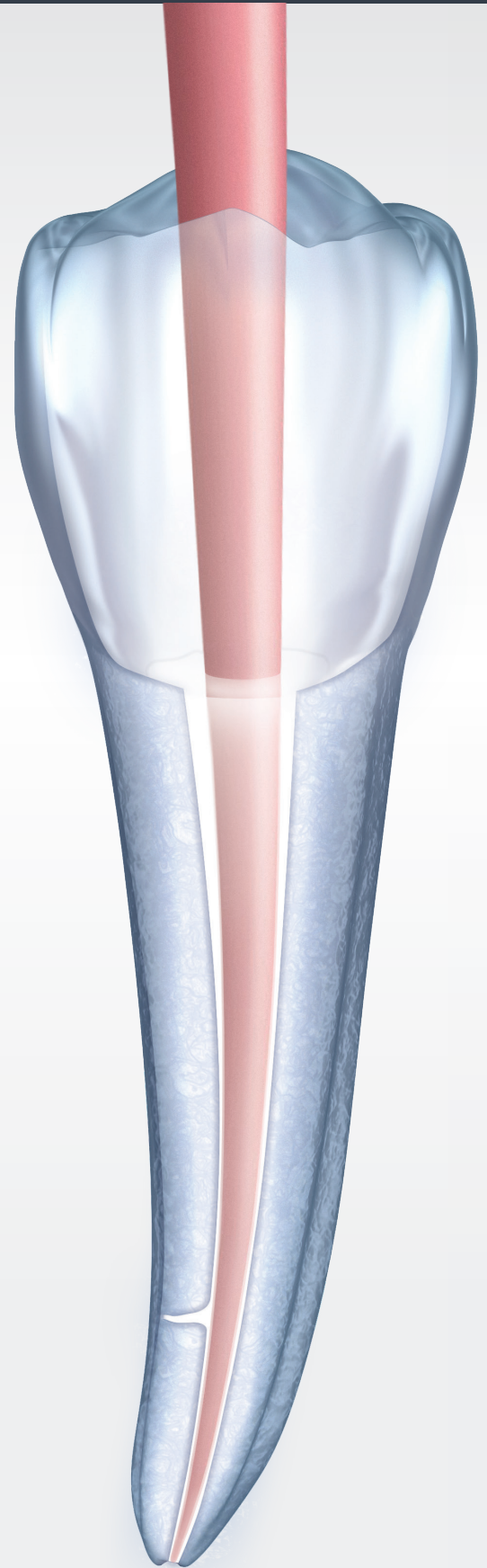

(1) Internal data. Pr Colon report

(2) Endodontic Implantation test . June 2020

(3) Mannocci. CED IADR 2019

(5) Drukteinis & Camilleri : Bioceramic materials in clinical endodontics. Springer 2020

(6) Internal data

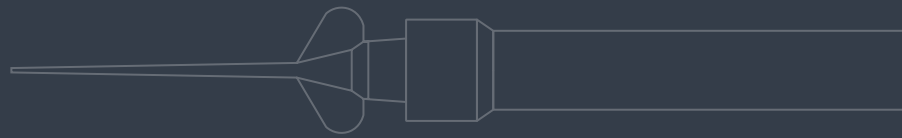

Biocompatible⁽⁷⁾

- ▶ High purity calcium silicate from proprietary manufacturing process
- ▶ Ensures favorable tissue response
- ▶ Limits the risk of adverse reaction

Bioactive: triggers mineralization⁽⁸⁾

- ▶ Calcium ion release forms hydroxyapatite
- ▶ Increases the mineral density of dentin

Allows best results even with single cone technique

- ▶ Unique benefits of calcium silicate enhancing cold technique efficacy
- ▶ Obturation is just as successful as with warm techniques⁽³⁾

(7) PA1704 Inflammation and regeneration potentials ; About 2021

Technical Insights

Hermetic seal of the root canal

- Excellent adhesion to dentin and gutta-percha
- Eliminates residual spaces for bacteria to grow

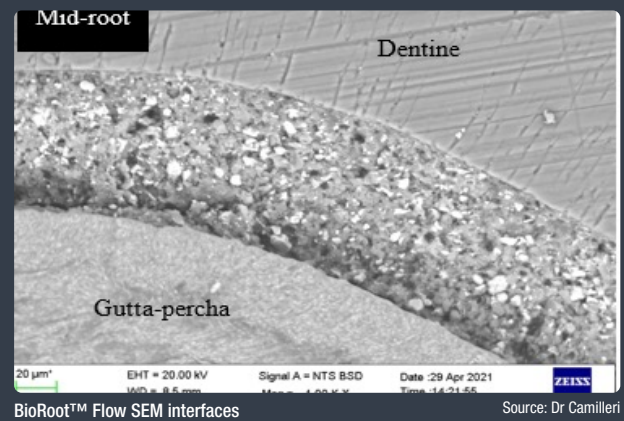

(8) Bioactivity and mineralization

- BioRoot™ Flow induces hydroxyapatite crystal formation by the reaction between calcium hydroxide and phosphate.

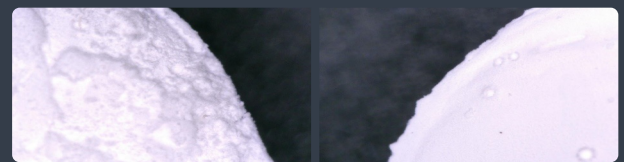
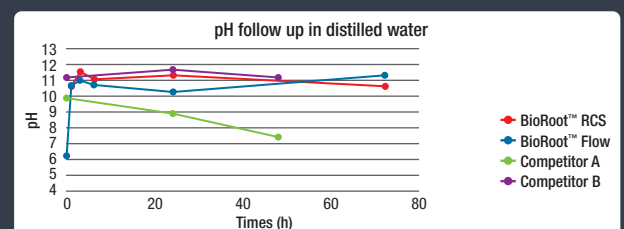

Image shows BioRoot Flow is immersed in Phosphate Buffered Saline (PBS - left picture) vs. water (right picture)

(4) Long lasting high pH

- High pH is maintained over time, creating an alkaline environment in which bacteria will not grow



Source: internal data

BioRoot™ Flow is made for everyone

Whatever your technique

Warm or Cold, BioRoot™ Flow allows reproducible success

Cold Technique

- ▶ No shrinkage ensuring no gaps or voids⁽¹⁾
- ▶ Excellent flow to penetrate accessory canals without compaction⁽²⁾
- ▶ Tight adhesion to dentin and gutta-percha for lower risk of bacterial infiltration⁽³⁾



Warm Technique

- ▶ Thin film thickness contributing to the clinical performance of the obturation
- ▶ Material remains stable while heated

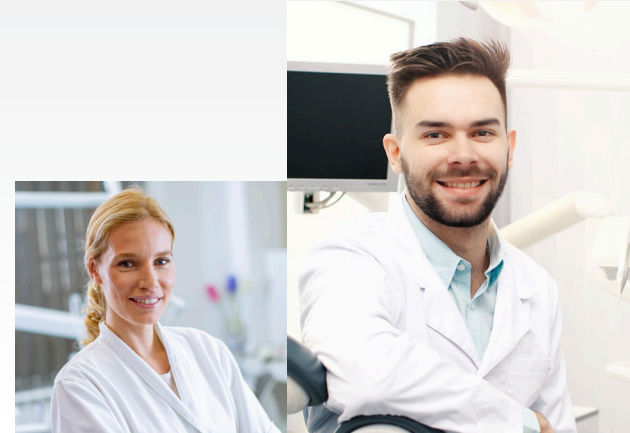

(1) Internal data. Pr Colon report

(2) Drukteinis & Camilleri : Bioceramic materials in clinical endodontics. Springer 2020

(3) BioRoot™ flow SEM interfaces. Dr Camilleri

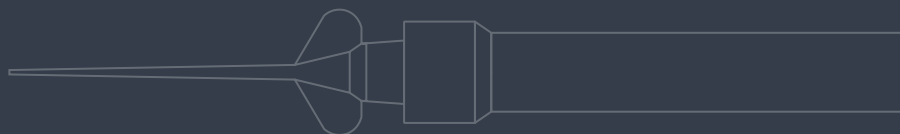

Whatever your practice

General dentistry or endodontics,
BioRoot™ Flow is designed for you

General Dentistry

- ▶ BioRoot™ Flow takes single cone technique to the next level
- ▶ Allows you to save chair time with each endo patient
- ▶ Giving you the confidence with quality obturation⁽⁴⁾



Endodontics

- ▶ BioRoot™ Flow penetrates areas that are hard to reach with a heated plugger (e.g. complex root canal anatomy)
- ▶ Consistent sealing quality whatever the obturation technique used⁽³⁾
- ▶ BioRoot™ Flow helps you save teeth by avoiding extractions



(4) Mannonci CED IADR 2019

Technical Features

Working time	>60 min	Radiopacity	6.3 mm Al
Setting time	5 to 6h00	Flow	23.2 mm
Extrusion Force	30N	Film Thickness	20.8 µm
pH	8.5 - 11.5	Solubility	1.5%
Calcium release	High	Source: internal data; Dr Camilleri	



Product information

- 1x2g syringe
- 1x finger grip
- 20 intra-oral tips
- Item #01E0510



Septodont

205 Granite Run Dr., Suite 150 • Lancaster, PA 17601 • 800.872.8305

www.septodontusa.com

Follow us on social media channels:



R0322

